

General Motors Oxidation & Deposit Test

Engine Assembly Manual

**Contact Person
Bruce Matthews**

**GM Global Propulsion Systems
800 North Glenwood Ave
Pontiac, MI. 48340-2920
MC 483-730-322
Phone 248-830-9197**

**Revision 09
15-Feb-16**

Table of Contents

Hardware usage guidelines	Section 0
Revision Timeline.....	Section 01
New Block and Pre Hone Preparation.....	Section 1
Cylinder Block Honing.....	Section 2
Short Block Assembly.....	Section 3
Cylinder Head Assembly.....	Section 4
Long Block Assembly.....	Section 5
Final Dress and Instrumentation.....	Section 6
OH Technologies Special Test Hardware.....	Section 7
Parts Cleaning, Ultra Sonic Cleaner.....	Section 8
Special Test Equipment.....	Section 9
Parts List.....	Section 10
Reagents.....	Section 11

Section 0

Hardware usage guidelines

All materials used in this test must conform to acceptance guidelines as specified in the General Motors Oxidation & Deposit (GMOD) Test Procedure, the GMOD Test Stand Configuration Manual (TSCM), the GMOD Engine Assembly Manual, and any local regulatory mandates applying to the test facility conducting this testing.

Any changes in procedures or substitutions of qualified parts or materials must be approved by General Motors and/or The ASTM Test Monitoring Center or appropriate Surveillance Panel prior to their use in non-reference and reference oil tests.

Any parts or materials specified in this document that are found to be unacceptable for testing, both pre and post test, must be reported to the Test Sponsor, and the appropriate Critical Parts Distributor.

Unless otherwise directed, all parts and materials required for testing should be stored and used on a first in – first out basis.

Section 01

Revision Update Timeline

- 8/25/2014 Post August 2014 Build Workshop revision
- 10/13/2014 Mostly additions to section 2
- 2/5/2015 Sections 1, 2, 3, 5, 6, 10, and 11.
- 6/9/2015 Sec. 3.5 changed torque to 44 from 55,
- 6/23/2015 Added Engine Build Clearance Specification table and ring part numbers Section 3
- 10/26/2015 3.1 Post Hone cleaning procedure option A, option B.
2.21 Surface finish limit update post prove out tests
8-3 Parts Cleaning Procedure: remove Block word and clarify where Block Post Hone Cleaning Procedure is in this manual.
- 2/15/2016 2-20 Added sentence concerning the Surface Finish control charts
3-6 note concerning the larger oring for large core plugs
3-10,11. Added picture with OHT rear cover bolted to block
3-14. Removed note about oil pump measurements for the PM. Changed oil pump maximum usage from 6 to 4.
5-8,12. Added alternative fuel rail part number
7-07 Added picture of Rear Cover
10. Removed GM part number for rear cover and added new o-ring for larger core plugs in CPW parts.

Section 1

New Block and Pre Hone Preparation

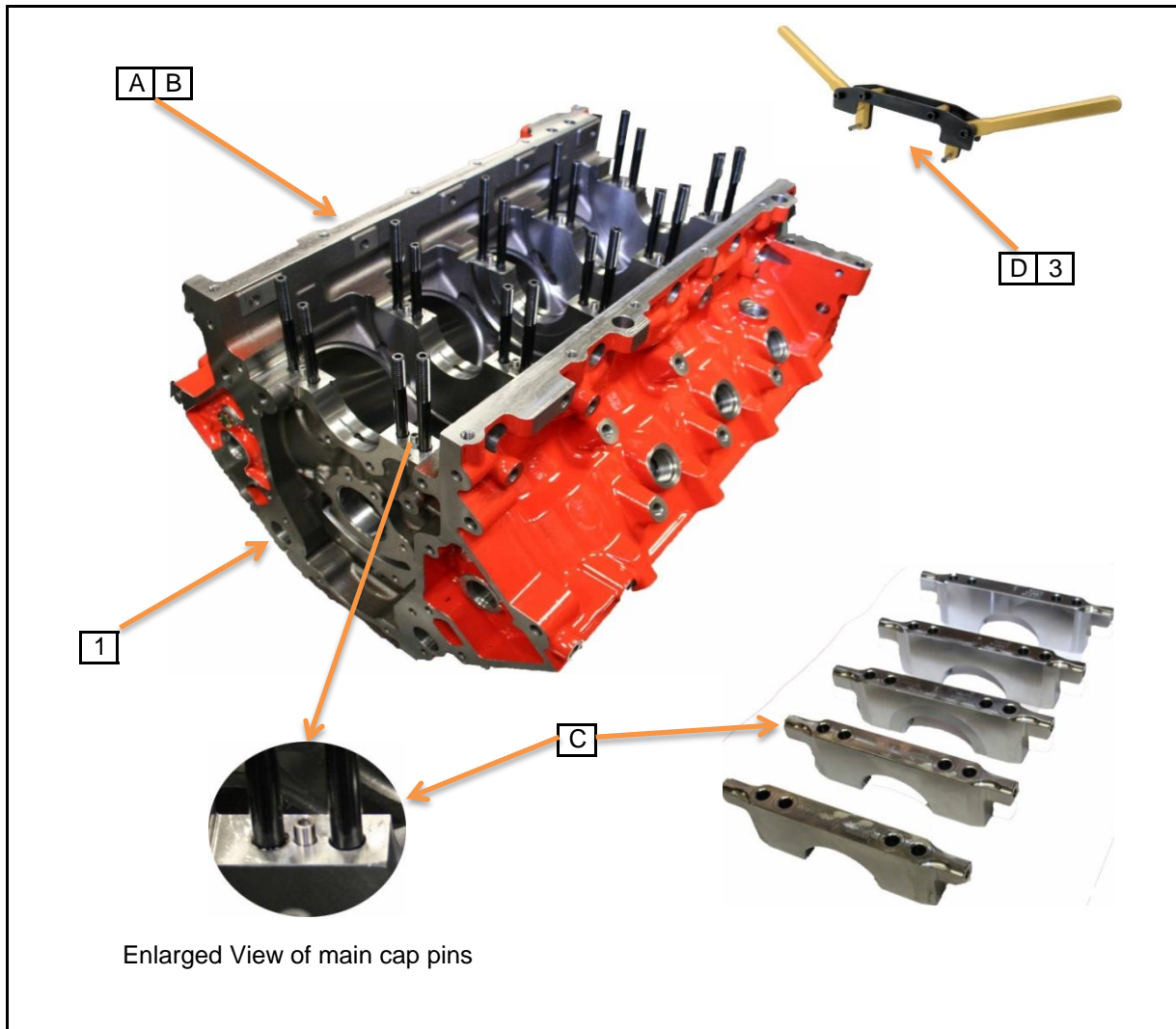

Enlarged View of main cap pins

Description of Operation

- A Upon introduction of a new block into the test lab, check for any damage to machined surfaces which might have occurred during shipping or handling.
- B Main cap fasteners are "ARP Stud Type" and are installed during machining of the block. Care should be taken to keep these studs and nuts with the engine block for the life of the block. If necessary to replace any of these materials, use only appropriate ARP replacement parts.
- C **Note: Main Bearing Caps are pinned on each side between the studs. Do Not Hammer or use excessive side to side or fore and aft rocking force during removal. Leaving the studs in place when the caps are removed will help prevent damage to the pins.**
- D After removal of main cap nuts, studs, and side bolts, carefully remove the main caps using the special main cap removal tool. **Labs must use one of the two special tools listed for proper removal.** Record engine serial number and assign a lab number as appropriate.

Specification

- 1 88958771 Block, GMOD Oil Test *
- 2 234-5608 Kit Stud, ARP
- 3 All Star Performance All 96525 Racing Head Service RHS 549106
- * Contact Chevy Performance for order information.

REV	Date	Revision History

View	
Pre Cleaning & New Block Prep	
New block, inspection, main cap removal, serial number and lab number recording.	

New Block and Pre-Hone Prep

GMOD

Section	Sheet
1	1

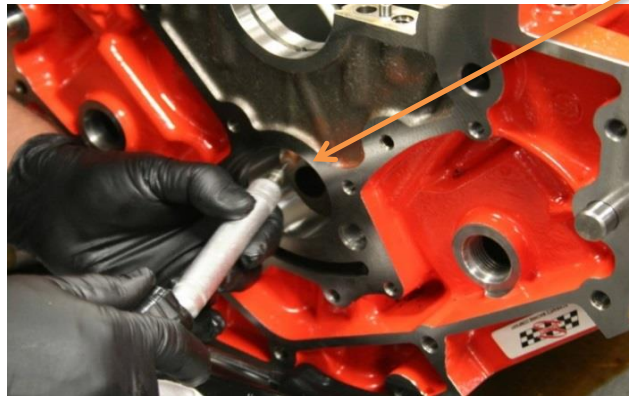

A
B
C

Description of Operation

- A Deburr all leading edges of the camshaft tunnel including the oil feed hole (not shown). Use air or electric rotary tools with carbide cutter or stone materials. A 2.5" 60 grit sanding wheel has been found to be effective in removing any sharp edge left by the cutter or stone. End result is to prevent cutting or gouging of the camshaft bushings during installation.
- B After deburring, thoroughly clean the engine block to remove all debris from the deburring operation.
- C Carefully inspect the post-test bushings after removal for evidence of distress on the outer diameters. Correct any possible areas of concern for the next installation.

Specification

--

REV	Date	Revision History

View
Camshaft Tunnel Deburring
Deburring of all leading edges including the oil gallery feed holes.

New Block and Pre-Hone Prep	GMOD
------------------------------------	-------------

Section	Sheet
1	2

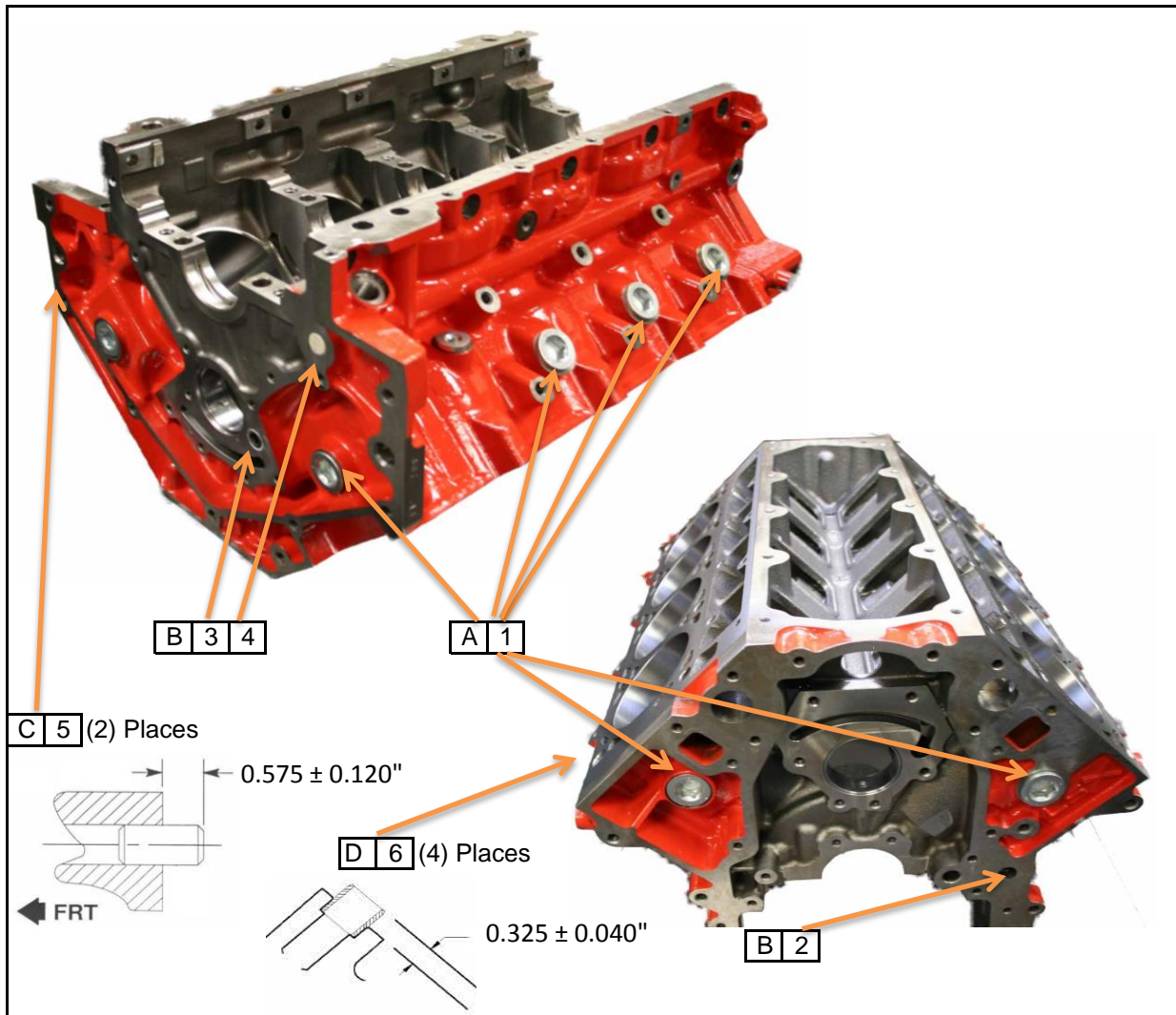

Description of Operation	
A	Remove all core sand plugs from front, rear, and sides of block.
B	Remove all oil gallery, threaded plugs, cup plugs, plastic insert plugs, and any special test cell oil gallery fittings.
C	If not already installed, install the rear transmission locating pins (2)
D	If not already installed, install the cylinder head locating bushings (4)

Specification	
1	AN Type Core Sand Plug (10)
2	9427693 Cup Plug Oil Gallery
3	14090911 Plug Threaded Oil Gallery
4	12573460 Plug Rear Oil Gallery Plastic Dog Bone Type with O-Ring
5	1453658 Pin, Transmission
6	12570326 Bushing Cyl. Head Location

REV	Date	Revision History
New Block and Pre-Hone Prep		GMOD

View	
Pre Cleaning Prep	
New and used block sand core and oil gallery plug removal.	
Section	Sheet
1	3

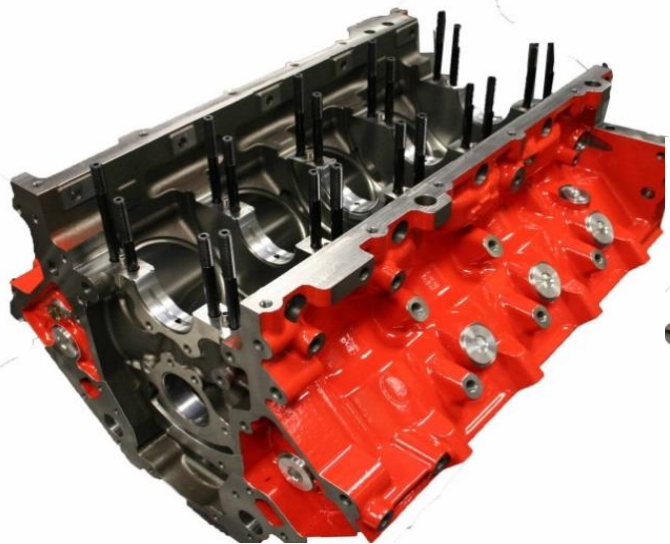

Bolt Torque Sequence

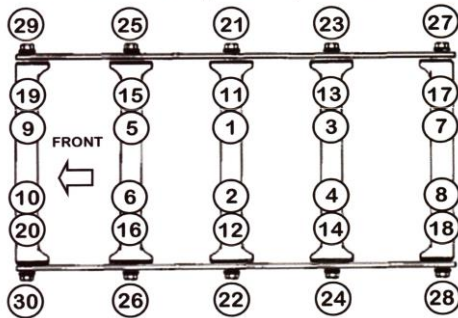

Outer Studs 4.55 long Nuts 50 lb.ft.
 Inner Studs 4.77 long Nuts 60 lb.ft.

M8 side bolts 20 lb.ft.



Description of Operation

A

Chase all threaded bores with proper thread chase if necessary.

Coat all studs with EF-411.

Install studs "hand tight" with speed handle. Follow torque specification chart for final application.

Note: To ensure caps are fully seated in block, apply 20 lb.ft. torque on inner stud nuts following crisscross pattern. Loosen nuts, back off three to four threads. Hold nut with finger while tightening stud to 100 inch pounds to ensure stud is fully bottomed in block.

Follow torque sequence in chart for final application.

Specification

--	--

REV	Date	Revision History

View	
Pre Hone & New Block Prep	
Main cap installation and fastener torque.	

New Block and Pre-Hone Prep

GMOD

Section
1

Sheet
4

Description of Operation

Parts cleaning guidelines

GMOD Test Engine parts may be cleaned using differing levels of cleaning prior to honing based on the level of post test cleanliness.

- 1) New blocks can go straight into the Ultrasonic Cleaner.
- 2) Used blocks can be sprayed with engine degreasing solvent if desired to remove heavy deposits before going into the Ultrasonic Cleaner.
- 3) Follow the Ultrasonic Cleaner Guidelines in the parts cleaning section 8.

Specification

REV	Date	Revision History

View

Pre-Hone Cleaning

Section

Sheet

1

5

New Block and Pre-Hone Prep

GMOD

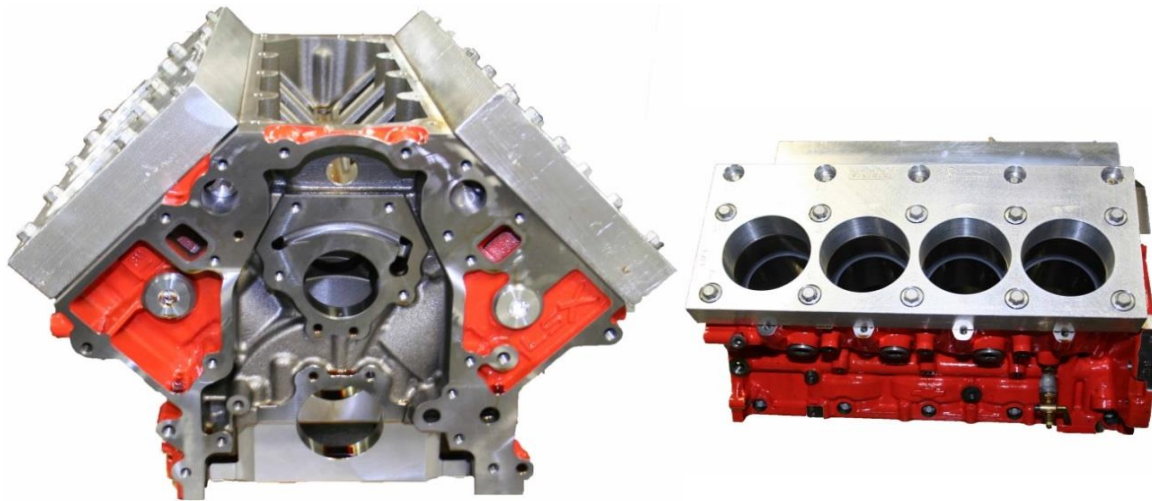

First Pass	M11 Bolts (1-10) in sequence 22 ± 2 lb.ft.
Second Pass	M11 Bolts (1-10) in sequence 90°
Final Pass	M11 Bolts (1-10) in sequence 70°
	M8 Bolts (11-15) in sequence 22 ± 2 lb.ft.

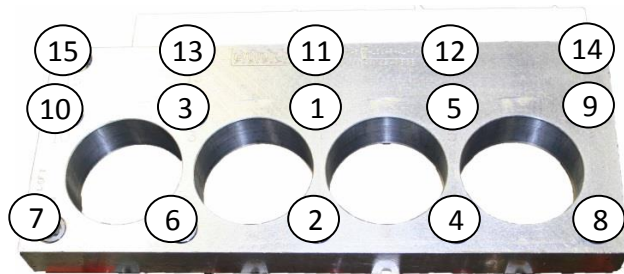

Description of Operation

- A Install BJJ Torque Plates with head gaskets. Lightly lubricate the NEW head bolt threads with EF411.
- B Torque fasteners following proper sequence according to the table
- Head Gaskets are to be used no more than twice with the torque plates. Labs need to identify each application and discard after the second use.
- The block is now ready for honing.

Specification

- 1 Plate Torque, BJJ GM5.7-LS1-R-AL-T-DID
- 2 Cylinder Head Bolt, long, 19258707
- 3 Cylinder Head Bolt, short, 12558840.

REV	Date	Revision History
New Block and Pre-Hone Prep		GMOD

View	
BJJ Torque Plate	
Torque Plate Installation.	
Section	Sheet
1	6

Section 2
2-15-2016
Cylinder Block Honing

GMOD Engine SUNNEN® Vertical Honing Machine Model SV-10 Setup and Maintenance

OPERATOR CONTROLS AND DEFINITIONS

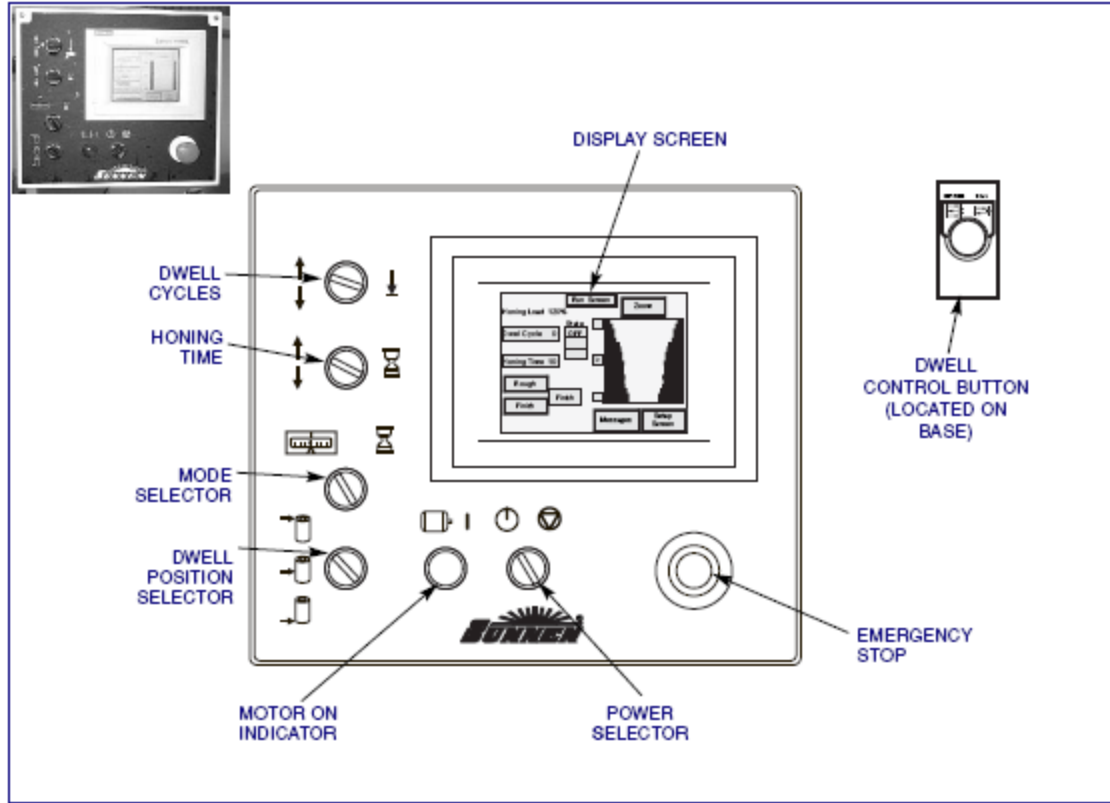

FIGURE 2-2, Operator Controls

TABLE 2-1, Operator Controls

















SYMBOL	DESCRIPTION	FUNCTION
DWELL CYCLES 	2 Position Selector Switch	Switch is used to set the number of strokes the machine will dwell at the location selected by the Dwell Position Selector Switch. (Count is found on the Run Screen.)
HONING TIME 	Selector Switch	Switch is used to set honing time in seconds, when a timed cycle is selected. (Time is found on the Run Screen.)
MODE SELECTOR 	2 Position Selector Switch	TIMED – Machine will hone until the number of seconds on the Honing Time display reaches zero. ZERO SHUTOFF – Machine will hone until zero is reached on the Graduated Feed Dial (5).
DWELL POSITION SELECTOR 	3 Position Selector Switch	Switch is used to select position in the bore that the machine will dwell at when the Dwell Cycle Switch or Dwell Button are used.
MOTOR ON INDICATOR 	Motor ON Light	When light is on, indicates that the machines pump is on and the machine is ready to start a cycle.
POWER SELECTOR (ON) 	Selector Switch	Turns ON electrical power to Machine's Operator Controls; places machine in standby mode.
POWER SELECTOR (OFF) 	Selector Switch	Turns OFF electrical power to Machine.
(EMERGENCY STOP) 	Red Locking Pushbutton Switch	Brings machine to an immediate controlled stop & removes all power to the machine functions. Button must be released to continue.

TABLE 2-2, Other Machine Controls & Warning Symbols

SYMBOL	DESCRIPTION	FUNCTION
	Warning Label	Warns that an electrical hazard exists.
	Dwell - Single	Depressing the Dwell Control Button momentarily will result in a single Dwell Cycle at location selected by Dwell Position Selector.
	Dwell - Continuous	Depressing Dwell Control Button for 2 seconds will result in a dwell cycle every cycle at location selected by Dwell Position Selector, until button is pressed again, removing machine from auto dwell mode.
	Cradle Height Adjustment	Indicates direction to turn elevating crank to raise cradle.
	Clutch Control	Indicates that when clutch lever is pushed back to (⊖) position motors are ON and the machine is in stand-by condition. When clutch lever is pulled to ⊕ position honing cycle begins. Warns that the clutch lever should not be pulled forward until honing tool is properly positioned within workpiece.
	Warning Label	Warns that no drilling is allowed. Drilling any new holes may void warranty.
	Warning Label	Warns that safety glasses should be worn at all times when operating this machine.
	Label	Designates this machine is "CE" compliance.

MACHINE SETUP

Getting Started / Setup

1. Turn power on by using switch located on the operator console.

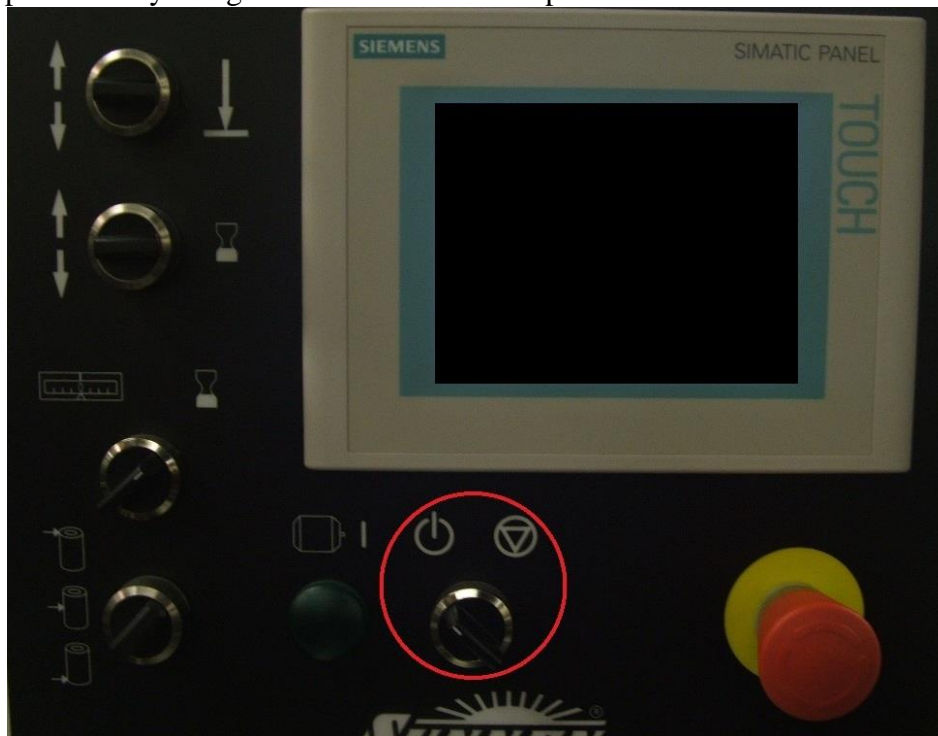

2. Wait for main screen to appear on the machine and select the setup key to take you to the 1st Setup Screen.

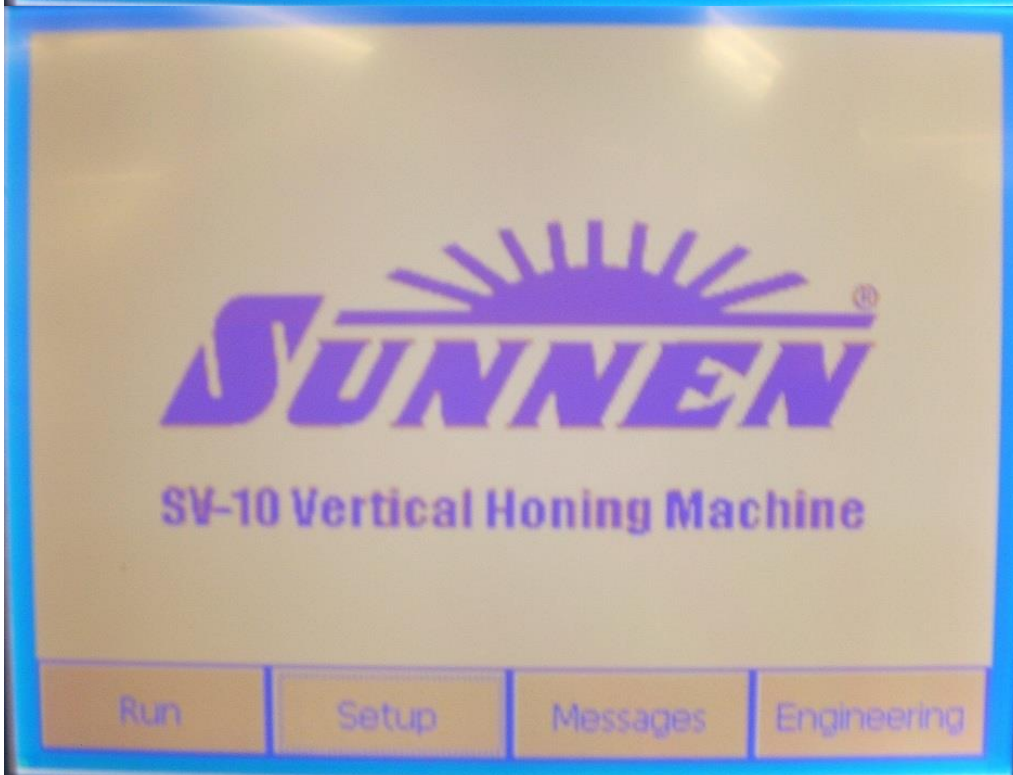

MAIN SCREEN

3. You may now enter the specifics of the job you are working on. (i.e. Bore diameter, Bore length, Stone Length, top & bottom over-strokes). If you would like to start over, press the clear button to rezero all of the parameters. You can also switch between inch and metric mode by selecting the “IN” or “mm” button respectively.

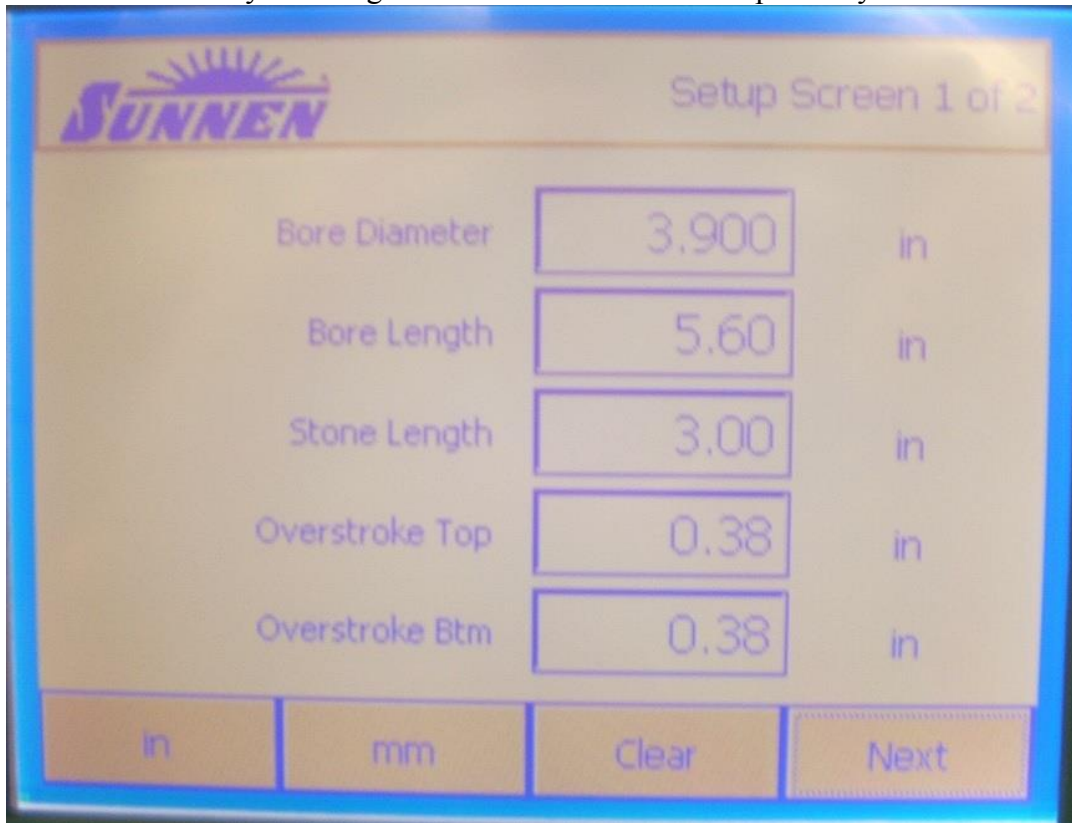

4. To enter data, simply touch the field with your finger and a keypad will appear that will allow the operator to input the necessary data.

KEYPAD

5. The data entered in this screen is completely optional. This data will allow the machine to calculate recommended stroke and spindle speeds, stroke length, and average cross-hatch angles. The machine will still operate if the 1st setup screen is bypassed.

CAUTION

Beware that if the 1st setup screen is ignored the data presented in the recommended speed, stroke length and x-hatch angle fields will be inaccurate and may cause a dangerous operating condition.

6. Use the next button to proceed to the second setup screen.

SETUP SCREEN 2

Set spindle and stroke speed

7. Using the data input on the Setup Screen 1, the machine presents a recommended Spindle and Stroke speed. Using this feedback, the operator can input both roughing and finishing speeds.

The screenshot shows the SUNNEN Setup Screen 2 of 2. It displays recommended and user-input speeds for roughing and finishing operations, along with average X-Hatch angles and a suggested stroke length.

SUNNEN		Setup Screen 2 of 2	
Spindle RPM	195	Recommended	
Stroke Speed	80	Recommended	
Roughing Spindle RPM	200	User Input	
Roughing Stroke Speed	70	User Input	
Finishing Spindle RPM	200	User Input	
Finishing Stroke Speed	70	User Input	
Avg. X-Hatch Angle Rough	34	Stroke Length	
Avg. X-Hatch Angle Finish	34	3.4	in

Buttons: Back, Run

8. To enter the speeds, touch the area of interest with your finger. This will open a keypad that will allow the operator to input the necessary data.

NOTE: Notice on fields that have minimum and maximum conditions that the limits are indicated on the top of the keypad

9. Notice that the avg. X-Hatch angle rough and finish update as the user inputs speeds.

10. Also located on Setup Screen 2 is the suggested stroke length for this setup.

NOTE: Notice that inaccurate data input on Setup Screen 1 can lead to an inaccurate recommended stroke length and may cause a dangerous operating condition.

11. At this point the operator can select BACK to go back to Setup Screen 1 or proceed to the Run Screen.

RUN SCREEN

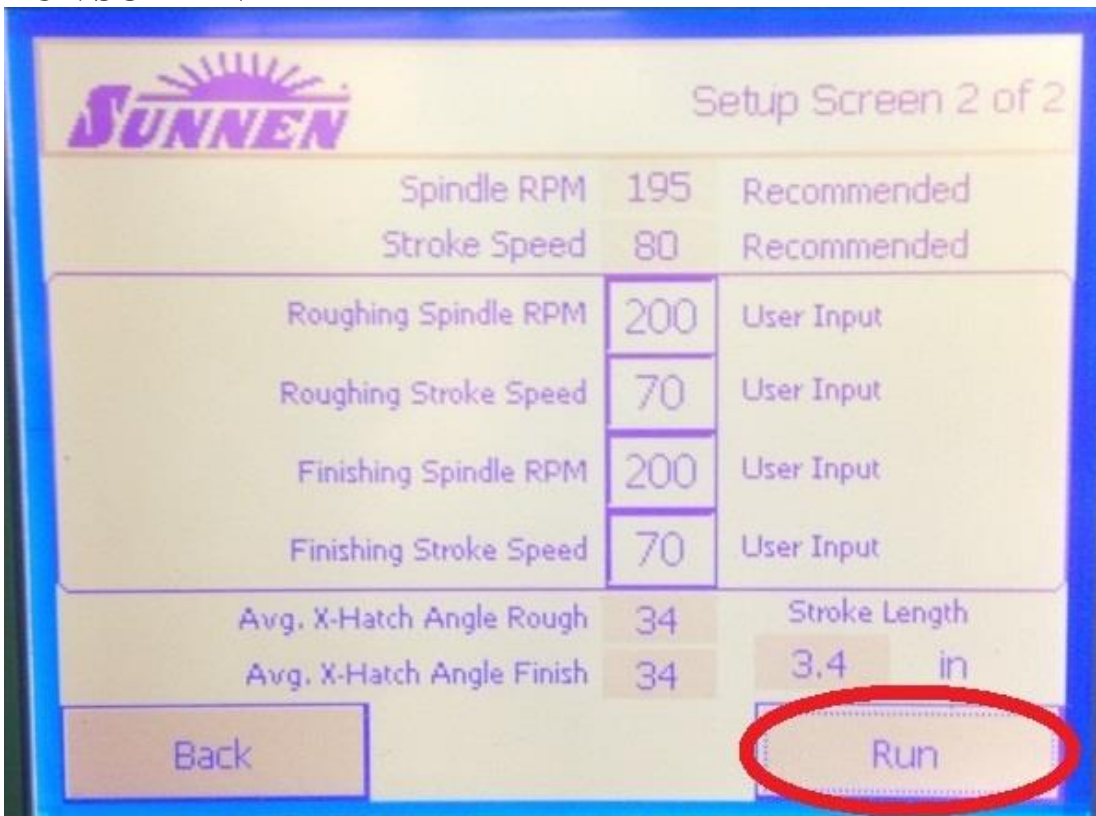

SUNNEN Setup Screen 2 of 2

Spindle RPM	195	Recommended
Stroke Speed	80	Recommended
Roughing Spindle RPM	200	User Input
Roughing Stroke Speed	70	User Input
Finishing Spindle RPM	200	User Input
Finishing Stroke Speed	70	User Input
Avg. X-Hatch Angle Rough	34	Stroke Length
Avg. X-Hatch Angle Finish	34	3.4 in

Back Run

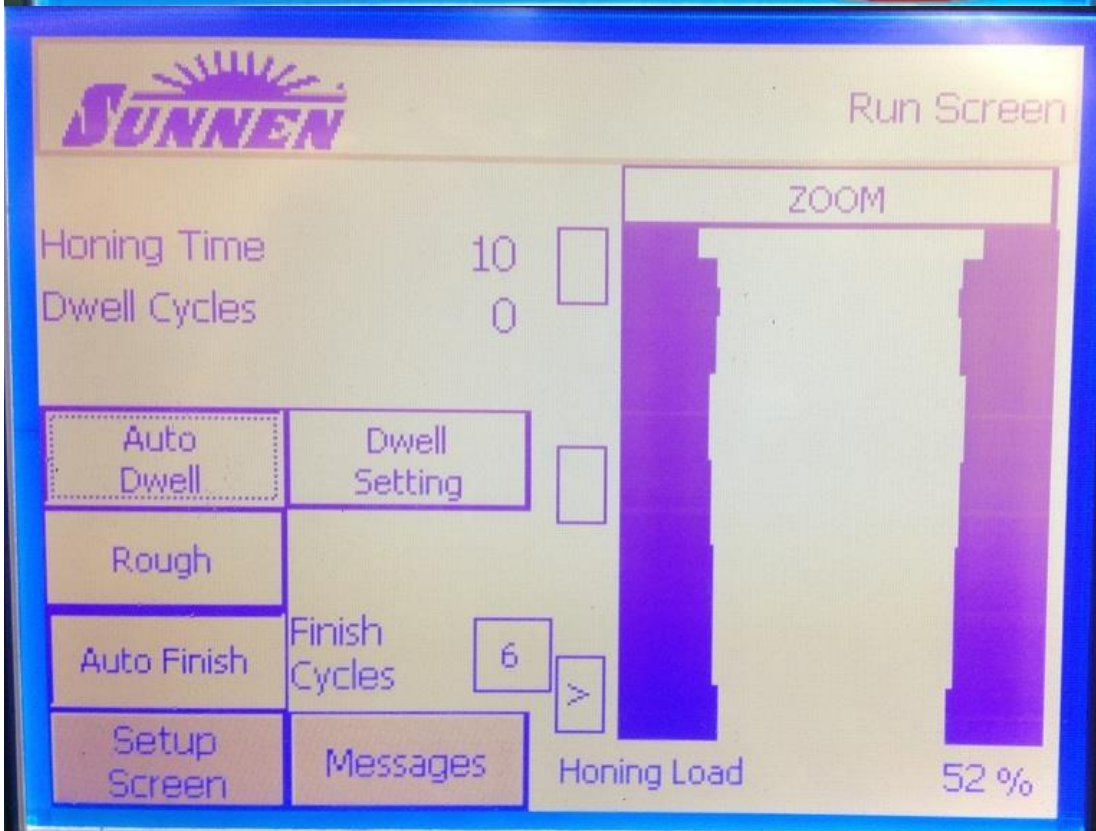

SUNNEN Run Screen

Honing Time 10

Dwell Cycles 0

Auto Dwell	Dwell Setting	<input type="checkbox"/>
Rough		
Auto Finish	Finish Cycles	6 <input type="checkbox"/>
Setup Screen	Messages	<input type="checkbox"/>

ZOOM

Honing Load 52 %

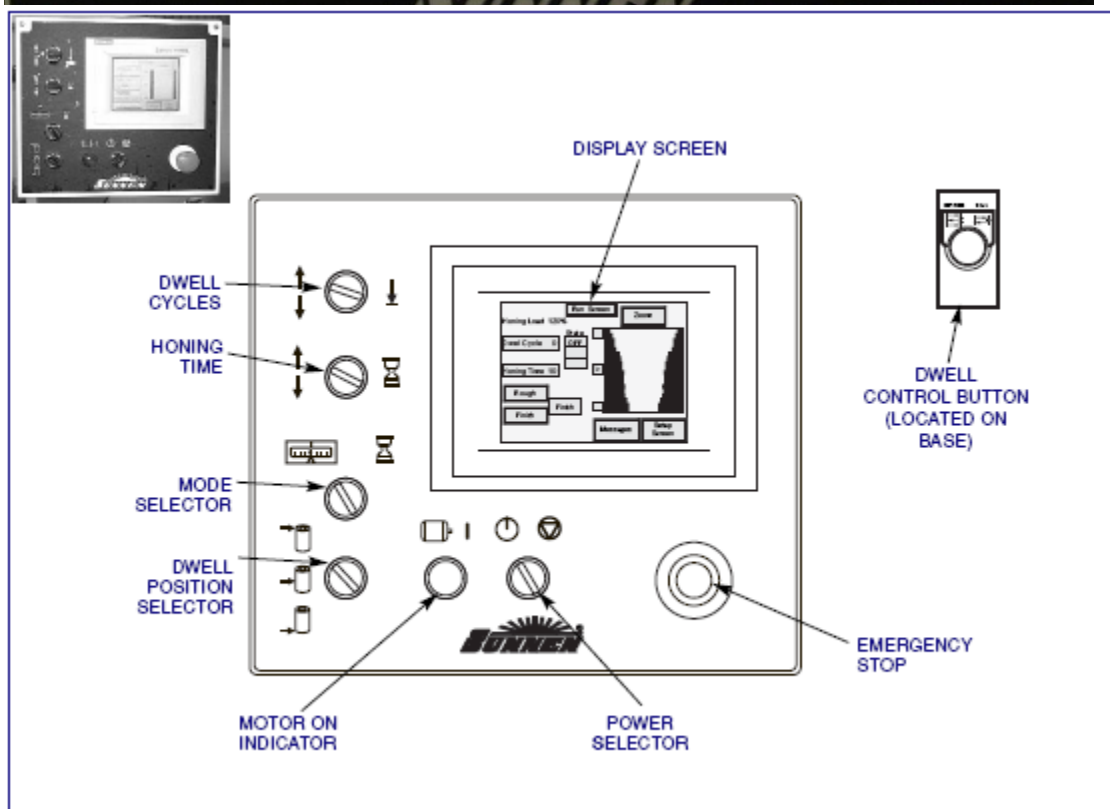
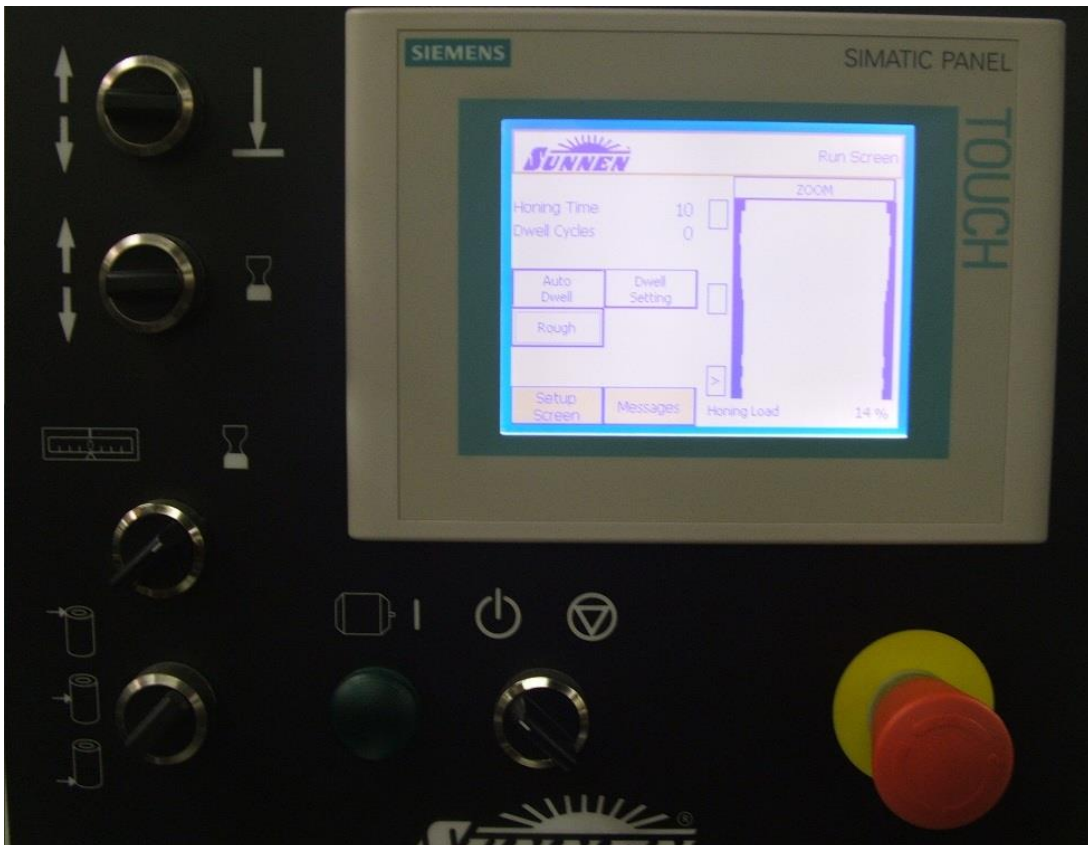

FIGURE 2-2, Operator Controls

Honing Load:

Will update as the spindle power requirements change during a cycle. (This is a percentage % of the spindle power used.) High Load Meter Reading: An initial load meter reading of more than 10% above reading for the previous cylinder indicates:

Feed Handwheel has been manually advanced too far.

Feed Handwheel has been manually advanced too fast.

In either case, the result is a higher than normal stone breakdown and a rougher than normal surface finish for that particular abrasive. Low Load Meter Reading: An initial load meter reading of more than 10% below the reading for the previous cylinder indicates the Feed Handwheel has not been manually advanced far enough, or it has been manually advanced too slowly. The surface finish left by the prior operation is too rough for the stones being used; therefore, an intermediate stone must be used between the rough and the fine finish honing operation. Stone glazing and smoother than normal surface finishes will result from incorrect Handwheel pressure. Erratic surface finishes and excessive finishing stone wear will result from incorrect Stone selection.

DWELL SETTING SCREEN

12. From the Run Screen, the operator must select Dwell Setting to DISABLE the Auto Adjust Dwell Cycles and Auto Dwell in Finish options from the Auto Dwell Settings options screen.

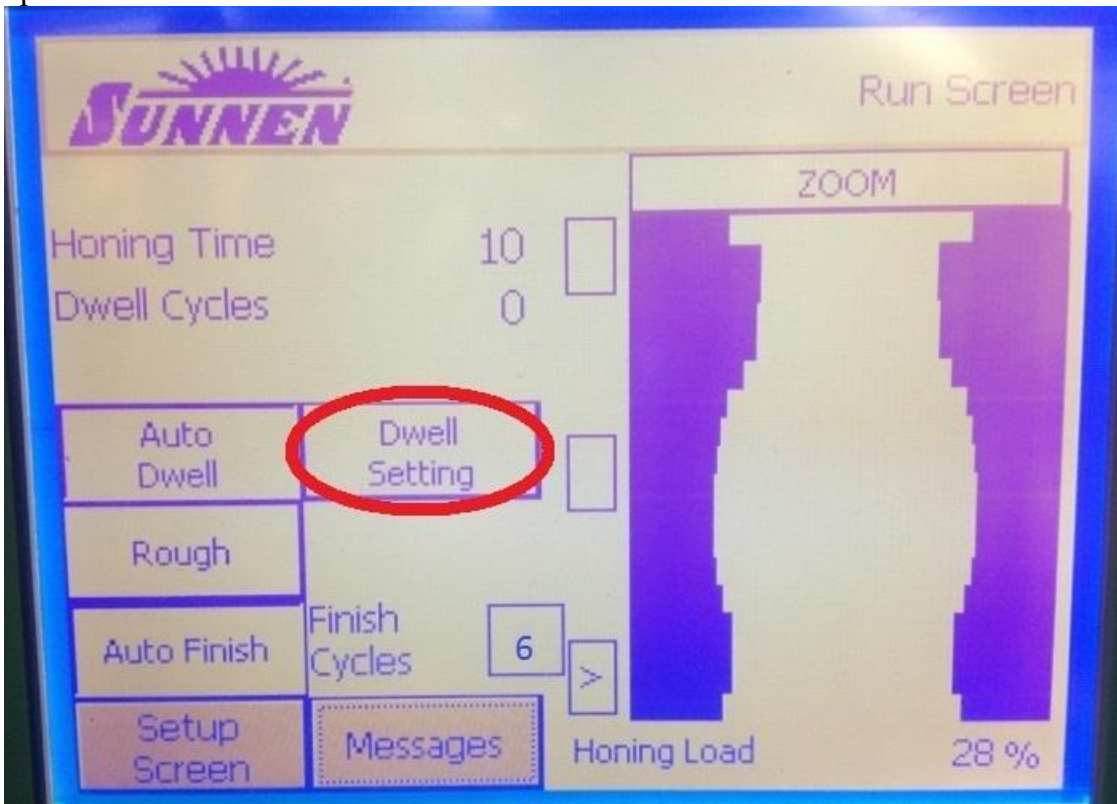

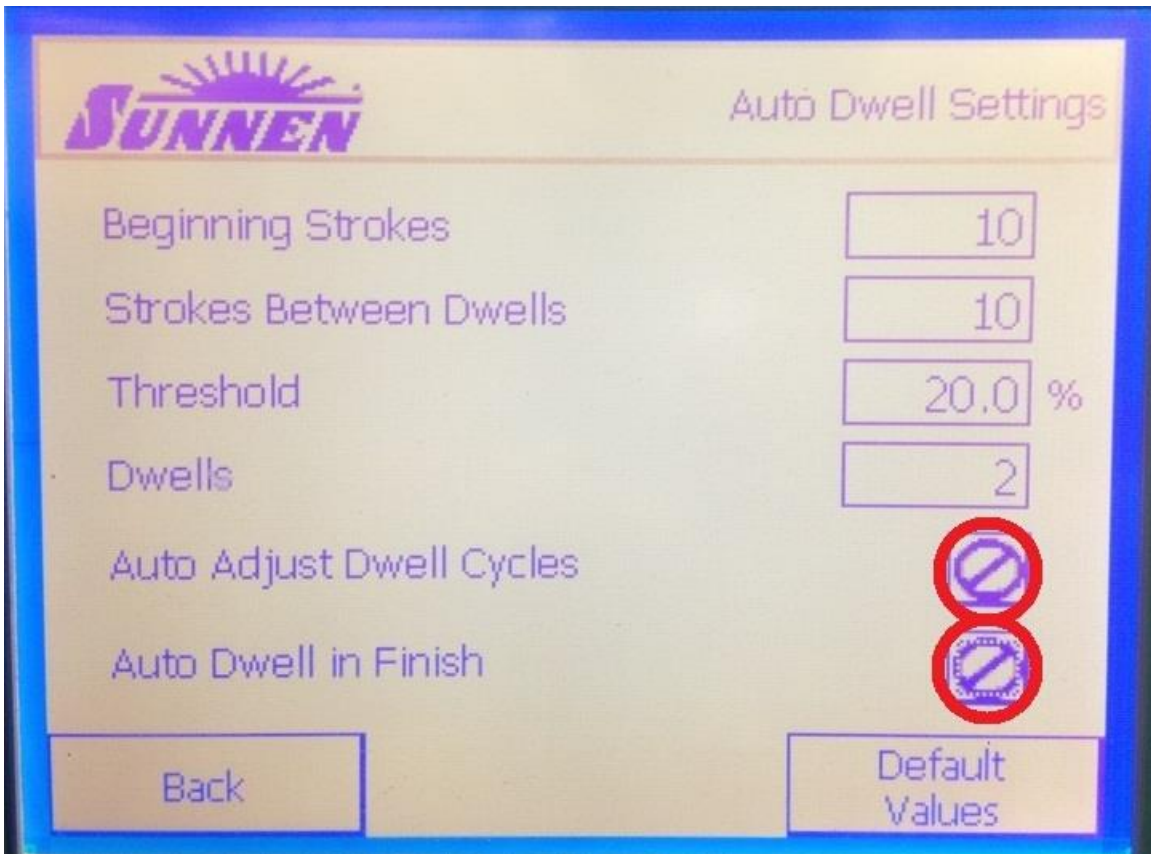

13. At this point the operator can select BACK to go to the Run Screen and select Auto Finish.

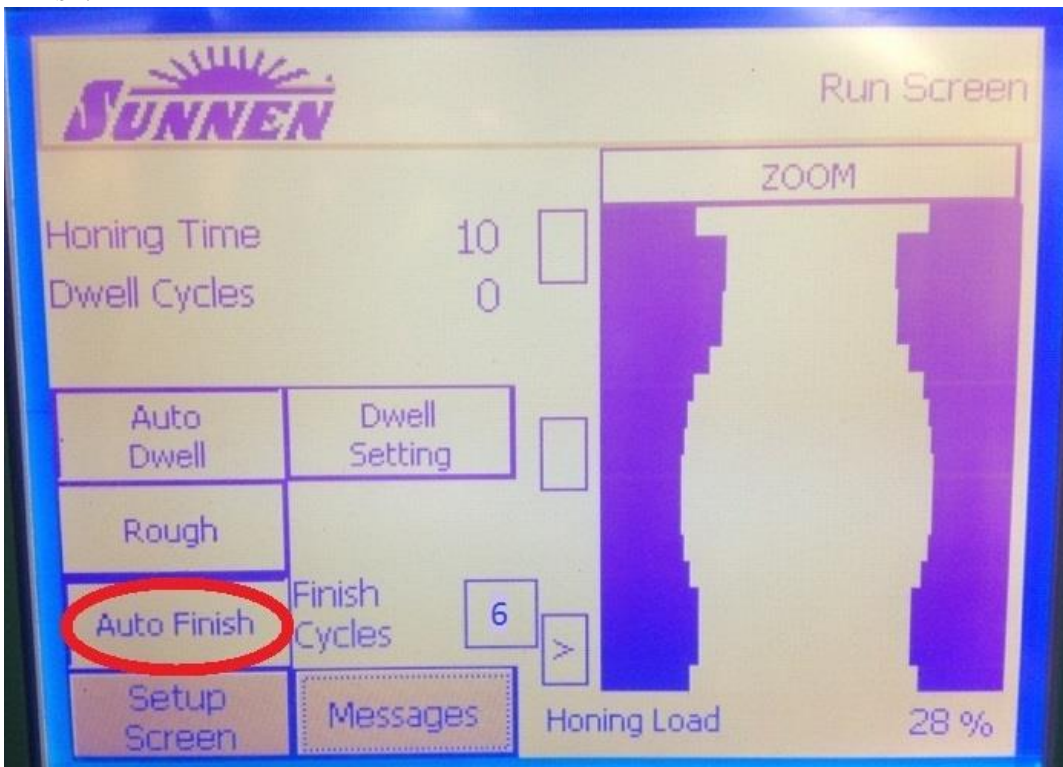

14. The Finish Cycles need to be set to 6 prior to proceeding with the hone.



Dwell Cycles:

Shows the number of strokes the machine will dwell at a location in the bore as selected by the Dwell Position Selector.

Honing Time:

Displays the number of seconds that the machine will run while in the Timed Honing mode as selected on the operator console.

State:

Indicates the state of the dwell function (i.e. off, on, or on continuous). By using Dwell Control Button operator located on the workbase, the operator can push the button one time to dwell the machine 1 cycle. This will switch the state indicator from Off to ON. The operator can press and hold the button for 2 seconds and dwell the machine every cycle until the button is depressed again. This will switch the state indicator from Off to On Cont. Note that the location of the dwell is determined by the Dwell Position Selector.

Rough / Finish buttons:

Switches the spindle speed and stroke rate between the rough and finish setup entered on Setup screen 2. For GMOD honing this is always set to Rough.

Event Message Exists:

This message reminds the operator to go to the message screen to review warnings or errors that may have occurred with the machine.

ERROR MESSAGES SCREEN

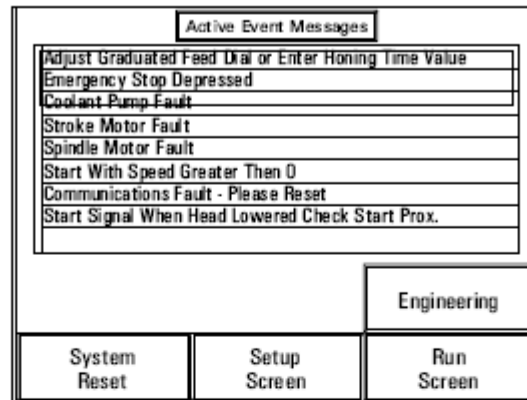

Adjust Graduated Feed Dial or Enter Honing Time Value:

If in zero shut off mode, the machine will not start if the feed dial reads zero from the previous cycle. Adjust dial, press "system reset" and restart. If in a timed cycle mode, the machine will not start unless there is a value other than zero in the display. Set time, press system reset, and restart.

Emergency Stop Depressed: Release Emergency Stop, press system reset and restart.

Coolant Pump Fault: Check that pump overload is not tripped. Press system reset and restart.

Spindle Motor Fault: Press system reset and restart. Contact Sunnen if problem persists.

Stroke Motor Fault: Press system reset and restart. Contact Sunnen if problem persists.

Start With Speed Greater Than 0: This indicates that the machine was attempting to start and also turn the spindle and stoker at a given speed when the clutch control handle was pushed rearward. This is purely a safety feature that prevents the machine from running unexpectedly. Verify that the Clutch proximity sensor is secure. Verify that the Clutch pivot screw is secure. Press system reset and restart.

Communication Fault: Occurs during Emergency stops and may occur if constant communication is not maintained between the PLC, Drives, And Operator Station. Press system reset to clear and restart. If problem persists, verify wiring is secure in cabinet. If problem continues, contact Sunnen.

Start Signal When Head Lowered Check Start Prox: This indicates that the machine was receiving a signal to start at the same time the head was being lowered. This is purely a safety feature that prevents the machine from running unexpectedly. Verify that the operator was not in contact with the clutch control lever when the head was lowered. If problem persists, verify that the Clutch proximity sensor is secure. Verify that the Clutch pivot screw is secure. Also verify that the Head proximity sensor and target are in adjustment. Press system reset to clear and restart.

ENGINEERING SCREEN

Engineering Screen		
Sensor Status		
Top of Stroke	OFF	Total Cycle Time
Zero Shutoff	OFF	= 15
Hone Head Down	OFF	Graph Scale
Cycle Start	OFF	= 2.0
Clutch Prox	< 100	TYPE
		< 100
Running Second		< 20
Panel Settings	Setup Screen	Run Screen

Sensor Status: Allows for troubleshooting of all machine sensors. Status of each sensor will toggle between ON & OFF when each function is performed. If a change in status is not seen, check switch for proper adjustment and make sure all cable connections are tight.

Total Cycle Time: Time in seconds the machine ran from when the Clutch Handle was pulled forward until the cycle ended. This number resets each time the Clutch Handle is pushed rearward.

Graph Scale: Graph Scale is a touch screen function that can be adjusted between two limits to adjust the magnification of the bore profile graph. (Tips: If spindle load is low, graph scale value should be set higher. If spindle load is high, graph scale value should be set lower.)

Running Second: Total spindle run time in seconds. This is a cumulative number that never resets.

Type: Should a persistent error occur, before any system reset, please record information presented in this field and have handy when calling for service.

Step: Should a persistent error occur, before any system reset, please record information presented in this field and have handy when calling for service.

ENGINEERING SCREEN

Getting Started / Engineering

1. Turn power on by using switch located on the operator console.



2. Wait for main screen to appear on the machine and select the Engineering key to take you to the Engineering Screen.

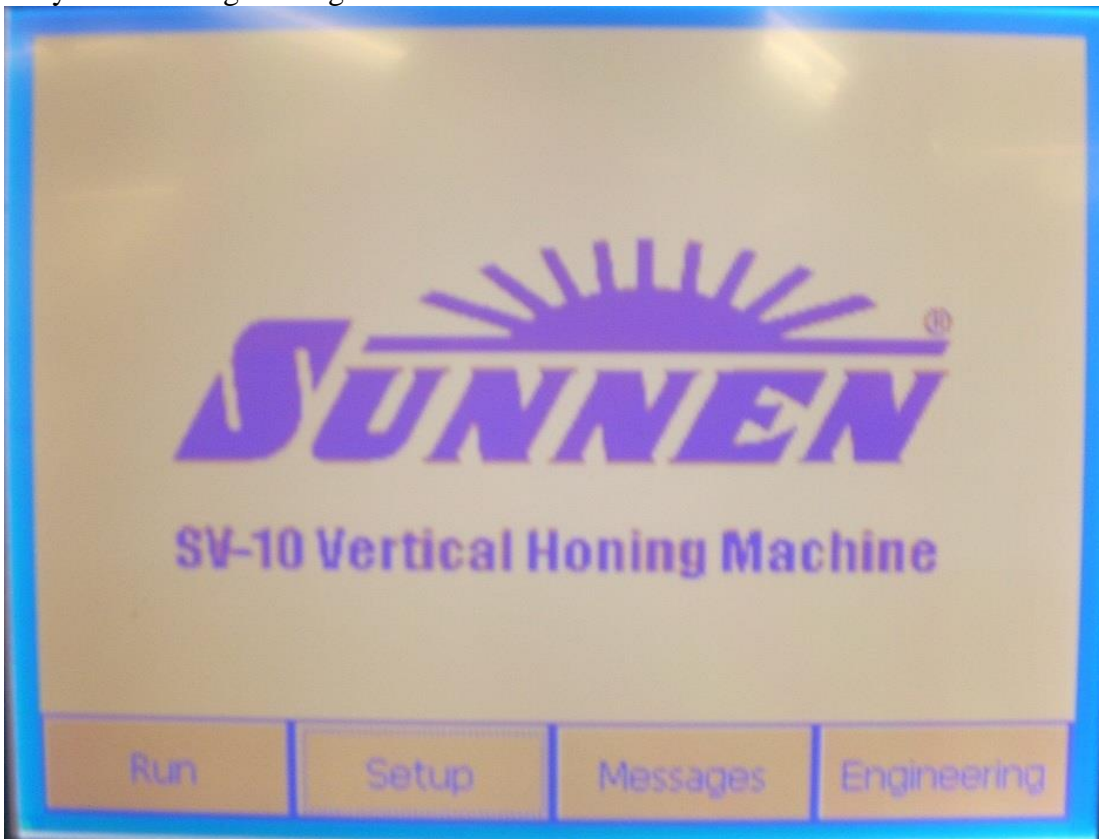

3. **Running Hours:** Total spindle run time in hours. This is a cumulative number that never resets.

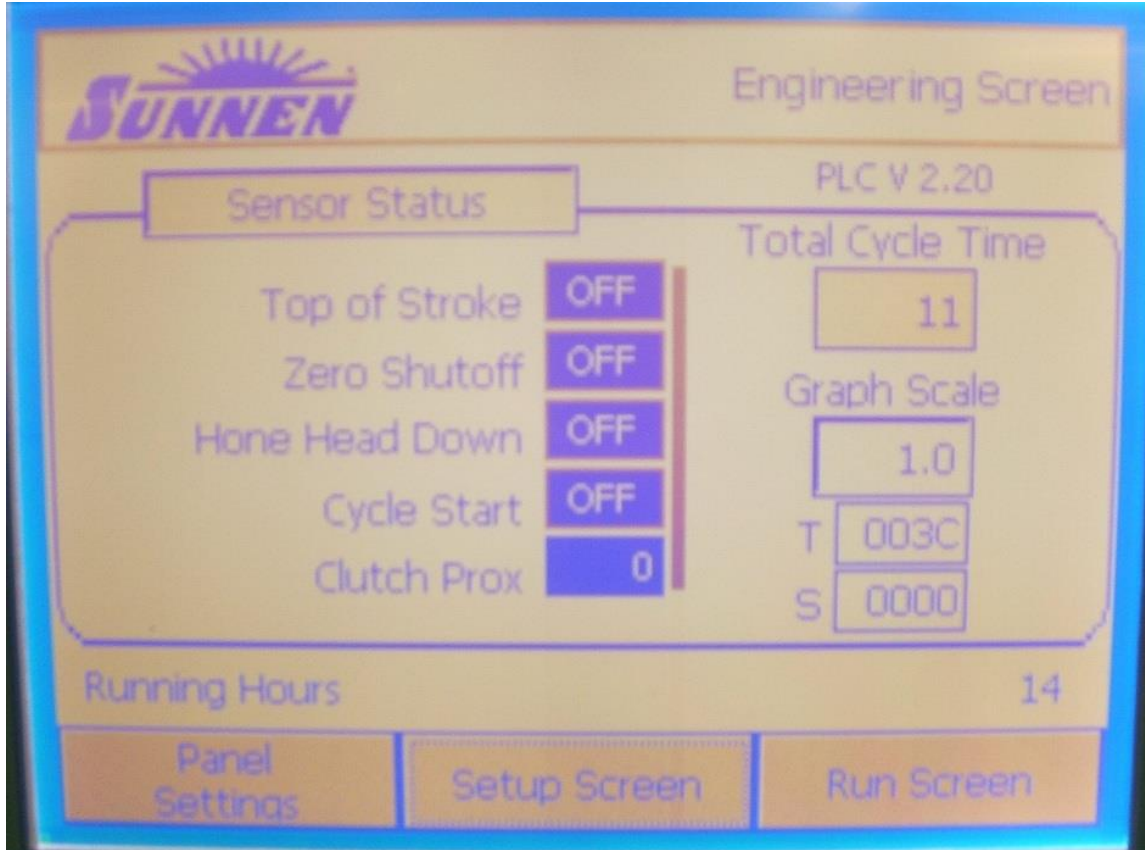

MAINTENANCE

Use the honing machine Engineering Screen Running Hours meter to determine hours of operation.

1. Replace the honing filters, CV1100 honing mats, and check the fluid level after every 15 hours of operation. Top off the fluid as necessary.
2. Replace the honing fluid in the honing machine after no more than 60 h of honing machine operation.
3. Follow the Sunnen recommended Routine Maintenance in the SV-10 Installation, Setup and Operations Instructions manual.

Citation

Installation, Setup and Operation INSTRUCTIONS for SUNNEN® VERTICAL HONING MACHINE (FOR AUTOMOTIVE & INDUSTRIAL APPLICATIONS) Model SV-10 (2005). *SUNNEN® VERTICAL HONING MACHINE Model SV-10*. SUNNEN®, St. Louis, MO. Intertek San Antonio, TX.

Materials

Honing Fluid SHO 965
Honing Fluid Filters PF 105 (5 micron)
Honing Matts CV-1100

Sunnen SV-10 Mechanical Setting and Trimming of the Lower Stone Holding Springs to prevent stone damage.

The Sunnen SV-10 has a mechanical setting in the head dependent on the bore length (see photo attached). The stroke length can be correctly programmed into the machine and will be performed despite the manual setting, however based on the manual setting the head can potentially contact the honing deck if not properly positioned.

The setting for GMOD block honing is as follows:

- i. 5.60" (bore length)
- 3.00" (to account for the length of the stones)
- + 3/8" (top overstroke)
- + 3/8" (bottom overstroke)
- i. 3.35" (manual setting for the SV-10)



Picture of 3.35" (manual setting for the SV-10)

Trimming of the Lower Stone Holding Springs

These springs needed to be trimmed at the bottom of the honing head due to the GMOD cylinder bore and the position of the main caps (shown in “GMOD Cylinder Bore” photo). Without being trimmed, the springs would contact the main cap portion of the block at the bottom of the cylinder when honing a fresh block. The “SV-10 Honing Head Top” photo depicts what the holding springs looked like before modification on the bottom of the honing head. The modification made is shown in the “SV-10 Honing Head Bottom (Springs Trimmed)” photo.



SV-10 Honing Head Top

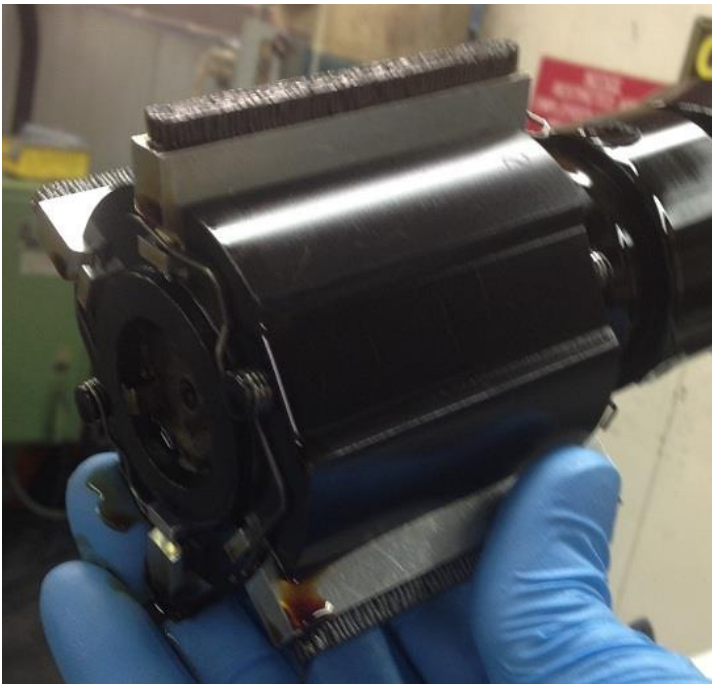

SV-10 Honing Head Bottom with the lower Springs Trimmed

Feed rate setting

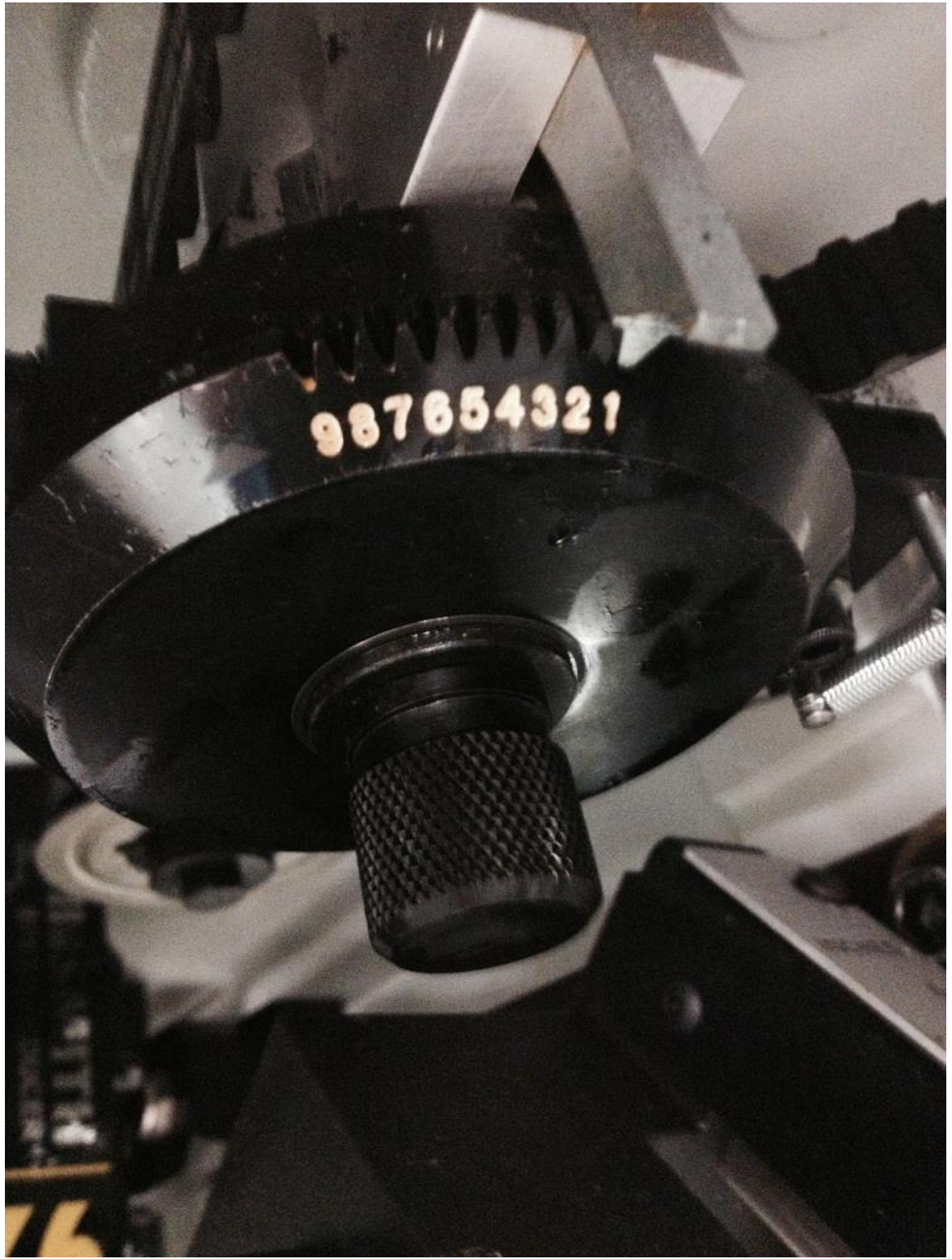

New stone break-in procedure

1. Using a honing practice block, start by using Dykem on the face of the stone and hone a cylinder bore.
2. Look for the contact pattern on the stone so if the Dykem has been removed then the stone is obviously higher in that position.
3. Use the white dressing stick supplied by Sunnen with the honing head, to rub the stone in the highest area.
4. The process is repeated until a good line contact is visible along the length of the stone. Typically we see that the stone radius will start in the middle of the stones and work its way to the outside of the stick.
5. Another process that can be used is lapping paste (fine grit abrasive and honing oil) that can be put in a cylinder and run to help break down the higher areas of the stone.

GMOD Engine Honing Requirements

- Block must be at room temperature before honing
- Torque plates and main bearing caps are to be installed
- New head bolts are to be used on the torque plates for every block hone.
- The flow rate of the honing fluid is to be set at 7 L/minute. This flow rate is to be measured and confirmed on a monthly basis. A log recording the dates of these checks is to be kept to confirm measurement frequency.
- Set feed rate to position 1. See picture on page 18.
- Hone Speed is set to 200 rpm for all steps
- When new diamond honing stones are first used it is important to ensure the stone exhibits full contact across the face. The Sunnen Dressing stone can be used to adjust the face.

Cylinder Honing Sequence

Follow the recommended honing sequence (5, 1, 7, 3 – 6, 2, 8, 4)

*Note: DO NOT hone adjacent cylinders

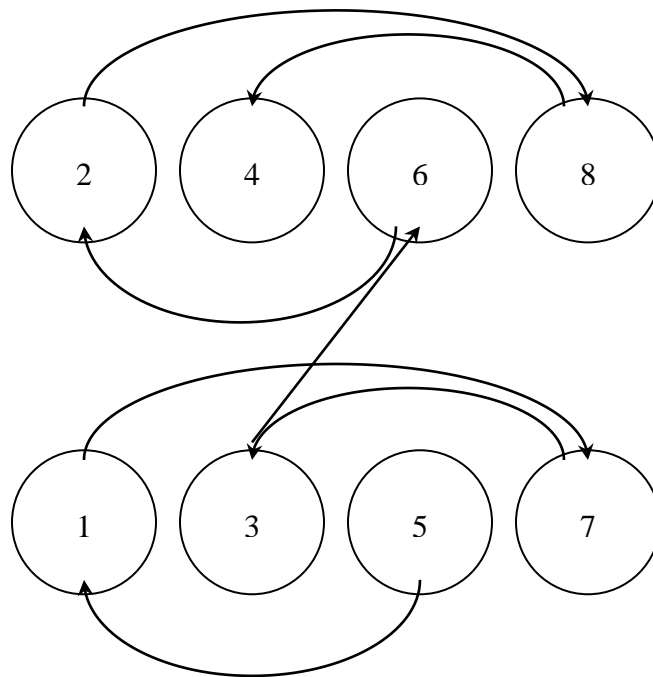

Honing Procedure

Step 1) Check the level of the honing fluid is within 1 inch (25mm) of the full mark. Add Honing Fluid SHO 965 if necessary.

Step 2) Hone the engine block to within 0.0005” of target bore size with **DHH7GMH55** and with initial load settings between 30-35%. As the machine hones the load may fluctuate but no further manual operator inputs to the Feed Handwheel are to occur after the initial load setting. Dwell switch set to Auto and select Auto Finish on the Run Screen. Set the number of Finish Cycles to 6 on the Run Screen. The machine will automatically enter the Auto Finish step after the Feed Handwheel reaches zero.

Step 3) Hone an additional 0.0005” to target bore size with DHH7GMH55 and with initial settings at 20-25% load. As the machine hones the load may fluctuate but no further manual operator inputs to the Feed Handwheel are to occur after the initial load setting. Dwell switch set to Auto and select Auto Finish on the Run Screen. Set the number of Finish Cycles to 6 on the Run Screen. The machine will automatically enter the Auto Finish step after the Feed Handwheel reaches zero.

Step 4) Set the hone timer to 15 seconds and hone with **DHH7RMH907** and with initial settings at 15-20% load. As the machine hones the load may fluctuate but no further manual operator inputs to the Feed Handwheel are to occur after the initial load setting. Dwell switch is set to Manual*.

Step 5) Set the hone timer to 10 seconds and hone with DHHB7534 with initial settings at 10-15% load. As the machine hones the load may fluctuate but no further manual operator inputs to the Feed Handwheel are to occur after the initial load setting.

Step 6) Measure and record the surface finish utilizing the Mitutoyo SJ-410 at 1.25”, 2.25”, and 3.25” from the top of each cylinder. Follow the **Mitutoyo Surftest SJ-410 Setup and Measurements Procedure** in this section to take these measurements. The average surface finish in each cylinder must meet the specifications in the table below. No re-measuring to find more favorable data is allowed.

Target Surface Finish (μ in)	
Rpk	1 - 12
Rk	1 - 41
Rvk	16 - 57

Record each cylinders average Rpk, Rk, and Rvk, in control charts so the honing process can be tracked and to prevent the occurrence of honing outside of the above target ranges. These control charts must be maintained and will be reviewed during the annual TMC inspections.

Step 7) Using a dial bore gage, whose setting has been verified with either a 99.000 mm or a 3.9000” certified master ring gage, measure the final bore size of each cylinder. Take transverse and longitudinal measurements at ¾” down from the deck, 1-¾” down from top measurement, and 1 ¾ down from center measurement.

A bore measurement ladder has been found to be beneficial for taking these measurements. Such a device can be found in the GMOD Test Stand Manual Appendix H.

The intent is to have the finished cylinders within +/- 0.0002in. of the target size.

Record the cylinder bore measurements in the Data Dictionary Form 18, A.1

Maximum allowable taper = 0.0127mm (0.0005in)

Maximum allowable out-of-round = 0.0127mm (0.0005in)

Step 8) Prior to cleaning in the ultrasonic bath the torque plates and main bearing caps are to be removed from the block.

***NOTE:** The reason the switch is turned to Manual is to avoid a Dwell occurring during the final strokes.

GMOD Engine Block Target Bore Sizes by Run Number						
Engine Block Run Number	Run 1	Run 2	Run 3	Run 4	Run 5	Run 6
<i>Target Bore Size (in)</i>	3.898	3.899	3.900	3.901	3.902	3.903
<i>Target Bore Size (mm)</i>	99.009	99.035	99.060	99.085	99.111	99.136

What to do if your surface finish is out of specification

1. Using the SF control charts determine whether a gradual change been occurring or if this is a sudden change.
2. If the stones are new have the stones had adequate bedding in time?
3. Check calibration of SF measurer.
4. Check the honing fluid flow rate
5. Examine the stylus tip.
 - i. Is it secure?
 - ii. Is it damaged? Use a magnifying glass to examine.
6. Check the security of the table holding the SF analyzer to ensure it is secure to the block.
7. Is the SF Analyzer correctly positioned on the holding table?
8. Replace the honing fluid and mats.

Mitutoyo Surftest SJ-410 Setup and Measurements Procedure

Power On

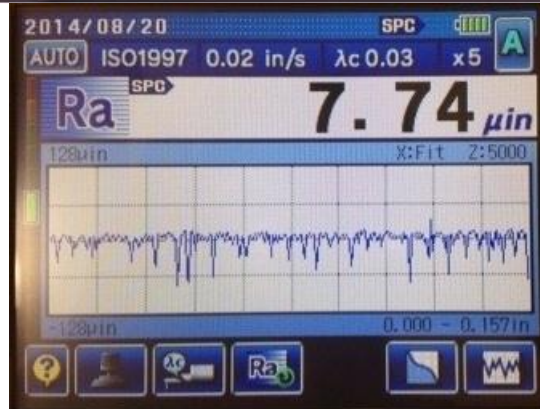

Select Stylus MENU

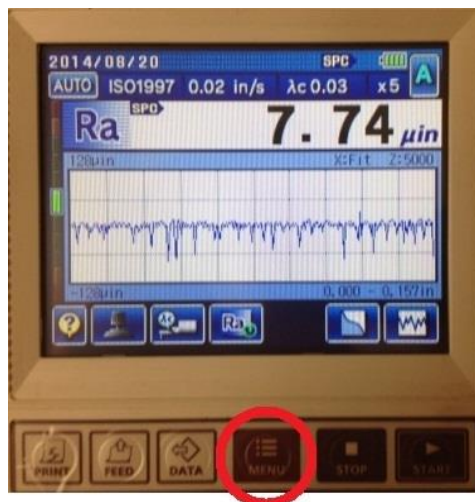

Set Environ.

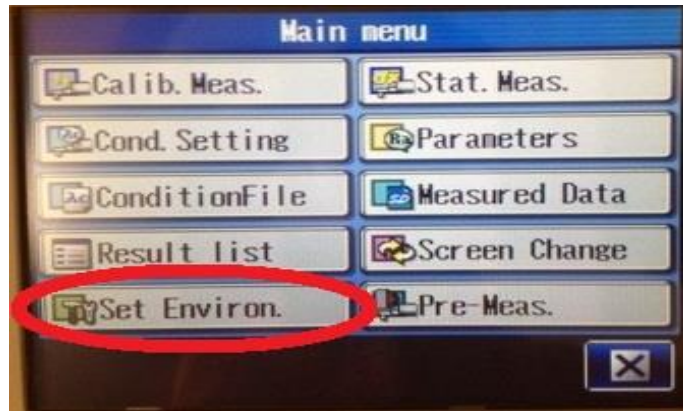

Select Stylus

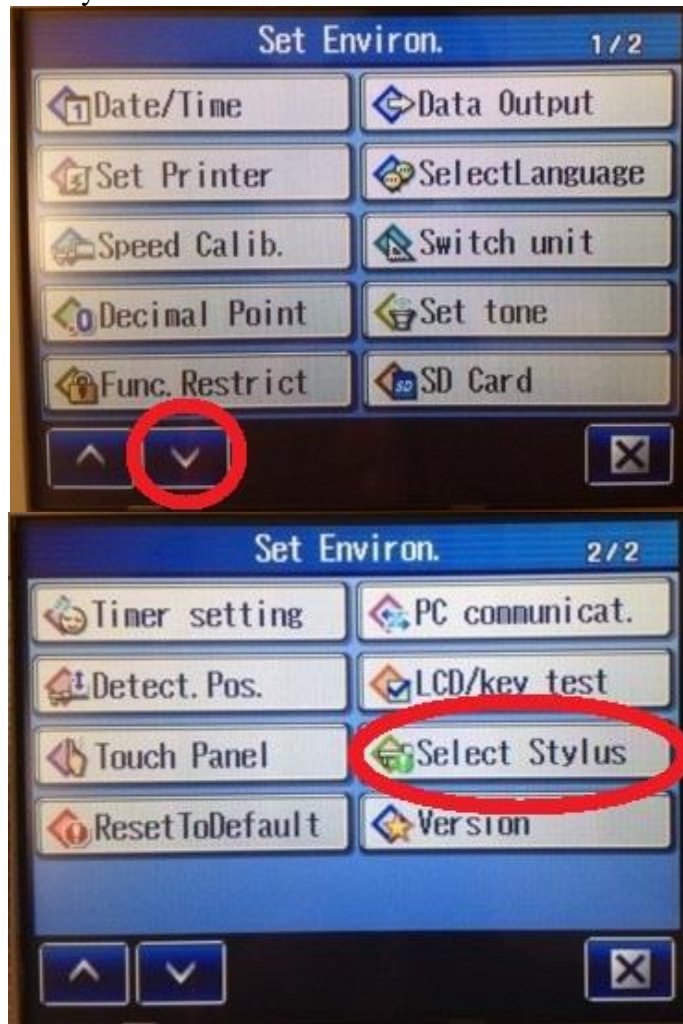

Select ***



Select 12AAB409: For deep groove (10mm)
Press Enter

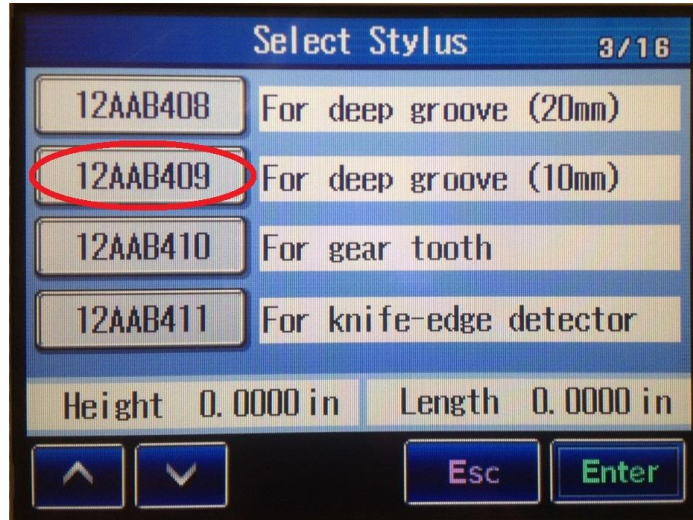

Highlight the correct Stylus
Press OK



Return to MENU

Condition Settings
MENU

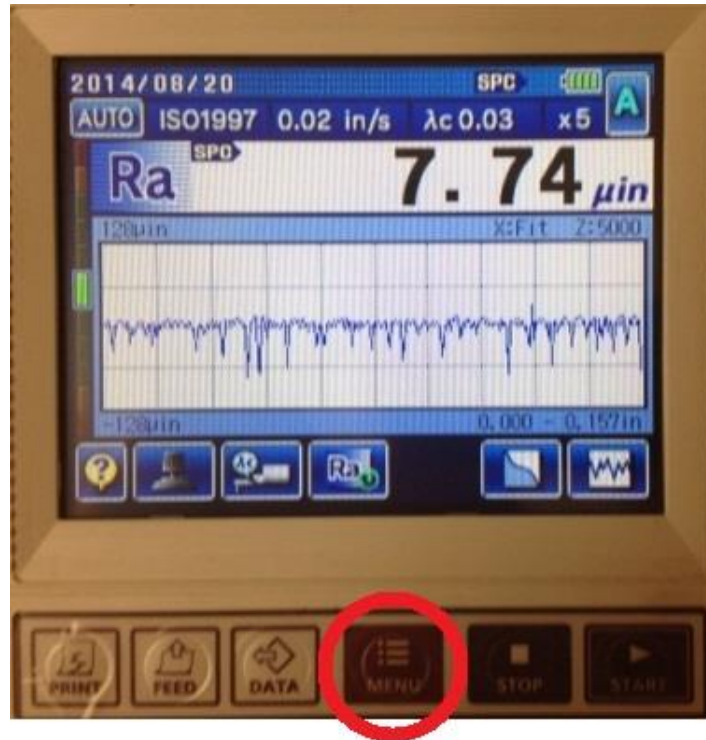



Cond. Setting
Standard: ISO1997



Profile: R



Parameter: Rk, Rpk, Rvk,



Filter: GAUSS

λ_c : 0.03 in

λ_c		in
0.003	$R_a \leq$	0.8 μin
0.01	$R_a \leq$	4.0 μin
0.03	$R_a \leq$	80.0 μin
0.1	$R_a \leq$	400.0 μin
0.3	$R_a \leq$	3200.0 μin
1	$R_a \leq$	*

Buttons: Ra, Rz, RSm, OK

λ_s : 100 μin

λ_s	μin
100	320
1000	

Buttons: OK

N: 5

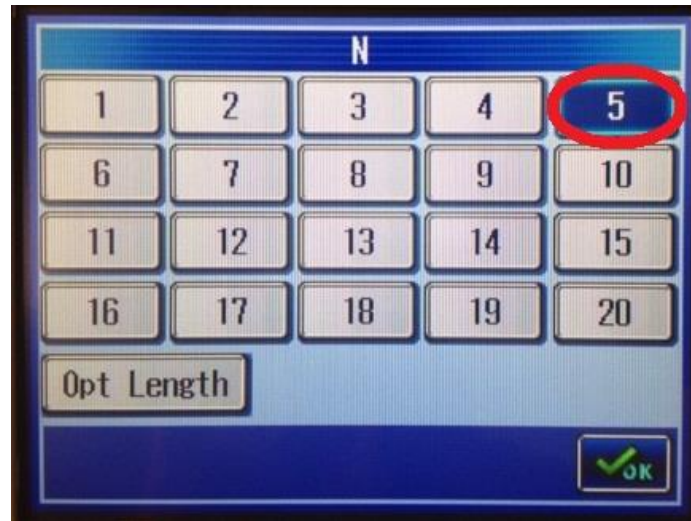

Pre/Post: ON
Del. Wave: OFF



Prof. Comp: OFF

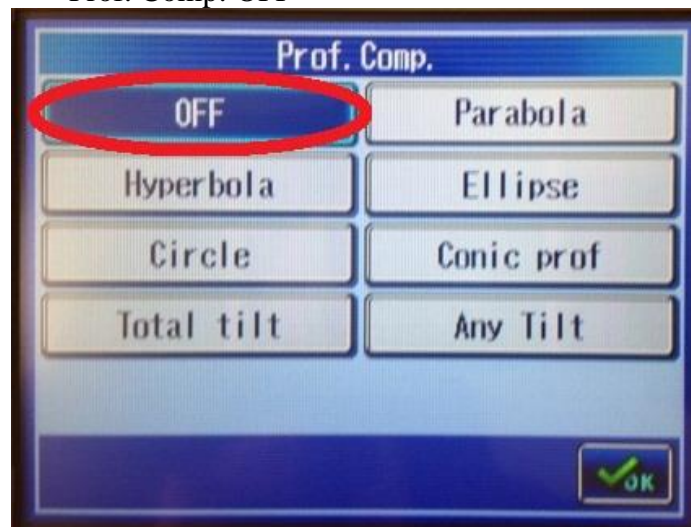

Mean Line: OFF
Return to MENU

Calibration Measurement
MENU

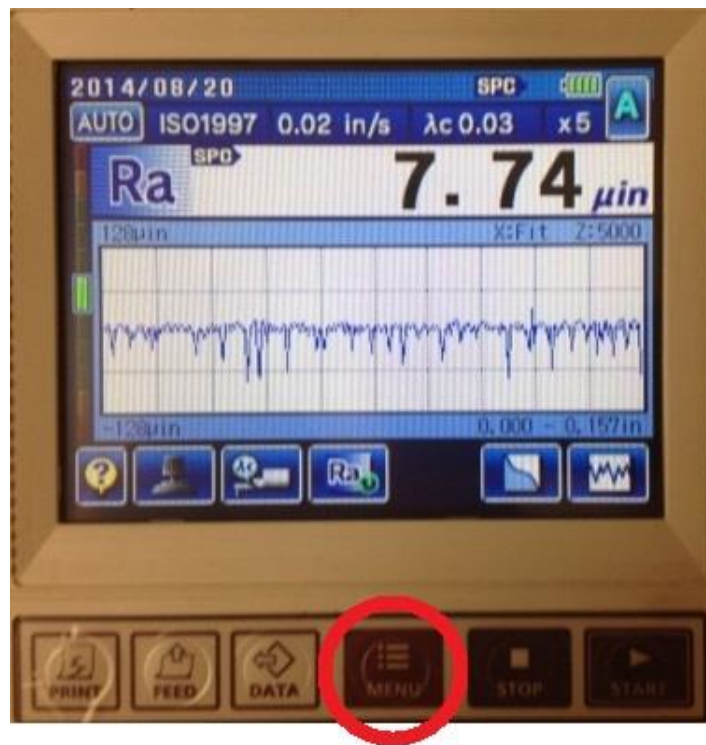

Calib. Meas.

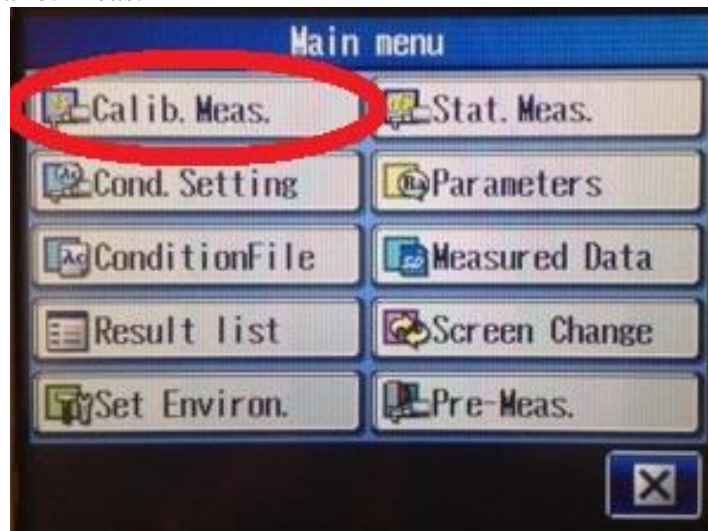

Touch Screen MENU



Nom Val.

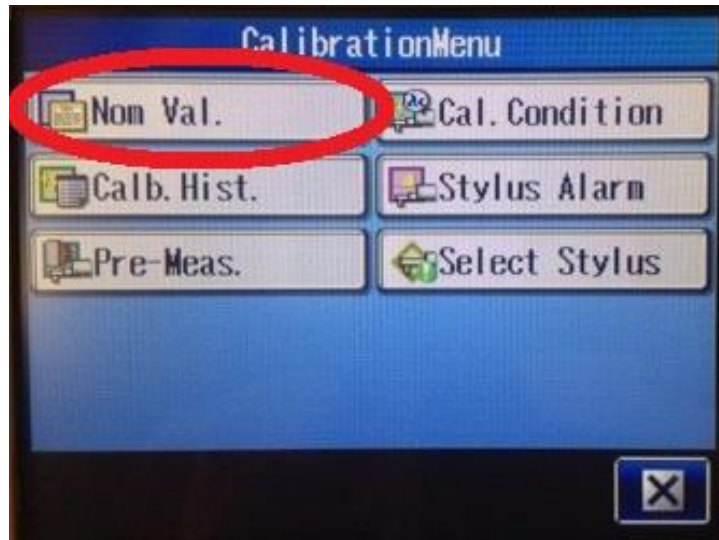

Specimen value: 117.00 μin
Press Enter



Perform leveling



Top knob (large adjustments)



Bottom knob (small adjustments)



START



Update Calibration Value



Recycle to discard Calibration Value



Return to MENU

Setup and Measurement

- 1) Leveling of the stylus in the liner is crucial.
- 2) Measuring fixture platforms are standardized for the test labs.
- 3) Conditional settings within the SJ-410 must be the same.
- 4) Skid nose piece needs to be in use when performing surface finish measurements.

Note: To perform the skid-attached measurement, turn the skidless/skid attached switching screw clockwise gently with a flat head crew driver to loose until it stops. This screw is located underneath the drive unit.

Mitutoyo SJ-410 Parts List:

Deep Groove Stylus (5 μ m tip): 12AAB409

Styli

For deep groove (10mm)

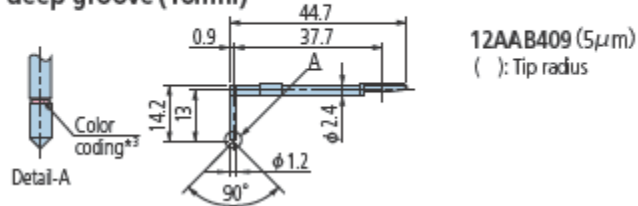

Skid Nose Piece: 12AAC755

Applicable skid nosepiece

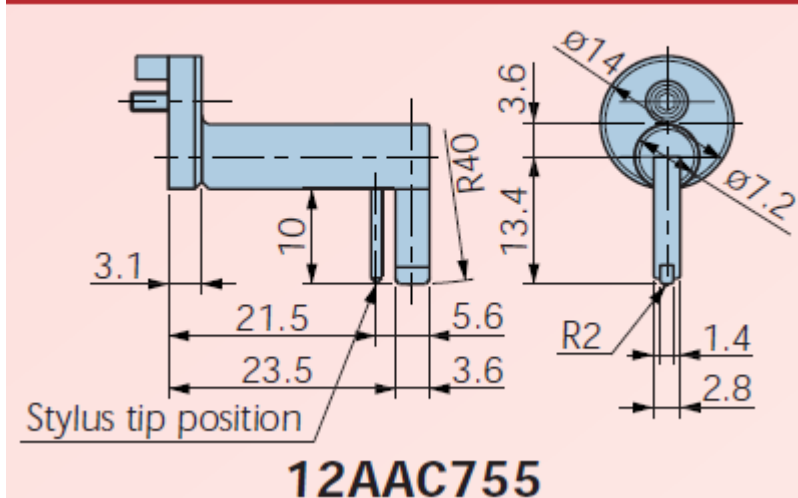

50 mm Extension: 12AAG202

Extension rods

- 12AAG202 Extension rod 50mm



Section 3 Short Block Assembly

2/15/2016

Engine Build Specification Table

Engine Build Clearances	Specification Inch/mm	Location in Section 3	Data Dictionary Page
Camshaft bearing clearance	0.0008-.0055" / 0.0203-0.1397 mm	Sheet 4	Form 19, A.8
Camshaft End Play	0.001-0.012" / 0.025-0.305 mm	Sheet 13	Form 19, A.5
Connecting Rod bearing clearance	0.0009-0.0025"/ 0.023-0.064 mm	Sheet 26	Form 19, A.11
Crankshaft Main bearing clearance	0.0008-0.0025"/ 0.02-0.065 mm	Sheet 8 & 9	Form 19, A.7
Crankshaft end play clearance	0.0015-0.0078" / 0.04-0.2mm	Sheet 9	Form 19, A.6
Cylinder bore out of round maximum	0.0005" / 0.0127mm	Sec. 2 page 21-22	
Cylinder bore taper maximum	0.0005" / 0.0127mm	Sec. 2 page 21-22	
Piston to cylinder bore clearance	0.003 – 0.005" / 0.076 – 0.127 mm	Sheet 23 & Sec.2 page 21-22	Form 18, A.2

A		A		Description of Operation	
<p><u>Post Hone Block Cleaning Procedure</u> Torque plates and main caps removed Follow <u>Parts Cleaning Procedure Steps 1 through 5 only, Section 8, page 3.</u></p> <p>Option A. Step 1. Clean block in sonic cleaner for 1 hr. Step 2. Quickly remove block from the ultrasonic cleaner and immediately spray with hot water for one minute. Do not spray over the ultrasonic bath. Step 3. Spray with 50/50 stoddard and EF-411 to remove the water and prevent rust and oxidation flash over. Step 4. Once block is cooled to room temperature, spray with 100% Stoddard and use a bristle brush on all internal surfaces including the cylinder walls using a nylon bore brush. Step 5. Wipe cylinder walls with a lint free white cloth to verify no rust or residue is left on cylinder walls. Step 6. Spray with 50/50 stoddard and EF-411 mix. Step 7. Air dry. Step 8. Proceed to Operation B.</p>		<p><u>Post Hone Block Cleaning Procedure</u> Torque plates and main caps removed Follow <u>Parts Cleaning Procedure Steps 1 through 5 only, Section 8, page 3.</u></p> <p>Option B. Step 1. Clean block in sonic cleaner for 1 hr. Step 2. Quickly remove block from the ultrasonic cleaner and immediately spray with 50/50 Stoddard and EF-411 mix. Do not spray over the ultrasonic bath. Step 3. Once block is cooled to room temperature, spray with 100% Stoddard to remove oil. Step 4. Air dry. Step 5. Rinse entire block with untreated water (deionized water is acceptable to use) using a bristle brush on all internal surfaces. Make sure cylinder walls are thoroughly brushed using a nylon bore brush. Step 6. Wipe cylinder walls with a lint free white cloth to verify no rust or residue is left on cylinder walls. Step 7. Spray with 50/50 stoddard and EF-411 mix. Step 8. Air dry. Step 9. Proceed to Operation B.</p>		A	Follow either Option A or Option B of the Post Hone Cleaning Procedure
				B	Clean out the holes in the crankshaft counter weights so all post test residue is removed.
				C	Check engine block, camshaft tunnel, lifter bores, oil galleries, gasket surfaces, and cylinder bores for cleanliness.
				D	No more than 8 oz. of EF411 is to be used in each engine build.
				Specification	
				View	
				Engine block post-hone cleanliness inspection	
Short Block		GMOD		Section	Sheet
				3	1

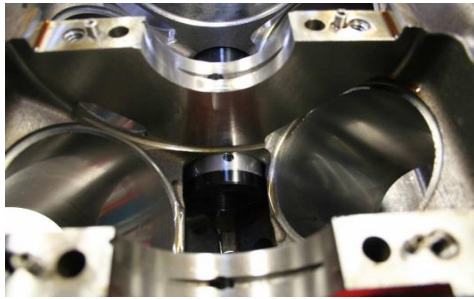

Camshaft Bushing Alignment Notes:

With Main Caps Removed;

- 1) Align bushing oil feed hole with drilled oil feed gallery from main bearing bore.
- 2) Position bushing 1 recessed from the machined face of the block.
- 3) A good practice is to use a pin light and view the oil feed hole in the bushing, ensuring it is lined up with the drilled passage through the main bore.
- 4) Make sure bushings clear lifter bores on front and rear of bushings.

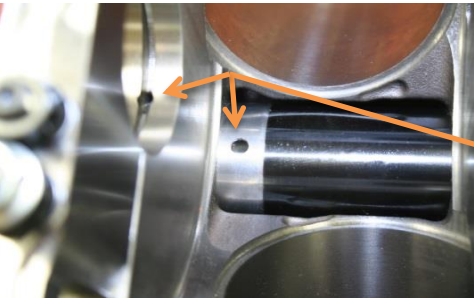

Align oil feed holes while installing bushings

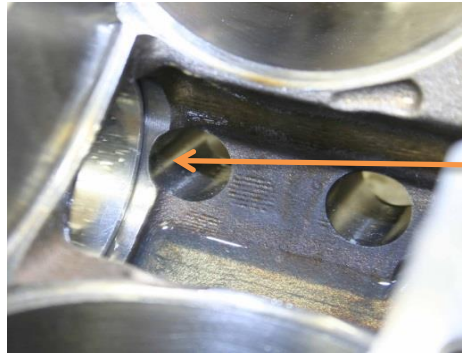

Oil Flow (Green Arrows)

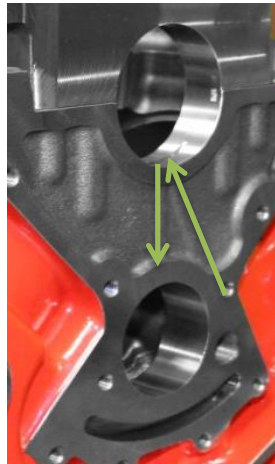

Lifter Bore (Breakout)

Description of Operation

- A Install the OHT Camshaft Bushings using the special OHT Camshaft Bushing Installation Tooling. (See Section 3 Sheet 3)
- B The GMOD LSX Oil Test Block has a priority oiling design which feeds oil off the main oil gallery straight to the crankshaft main bearings and then up to the camshaft bushings. Care must be exercised to align the oil feed hole in the bushings with the drilled gallery passage from the upper main bore. Care must also be exercised to position the bushings in the number 2,3,& 4 positions so they are equally spaced between the lifter bore holes on each side of the camshaft bushings. The front bearing is to be installed flush with the block face. This improves alignment of the oil holes in bearing and block.
- C

Specification

- 1 GMOD 001-06 Camshaft Bushings 1-5

REV	Date	Revision History
Short Block		GMOD

View	
Camshaft Bushing Installation	
Section	Sheet
3	2

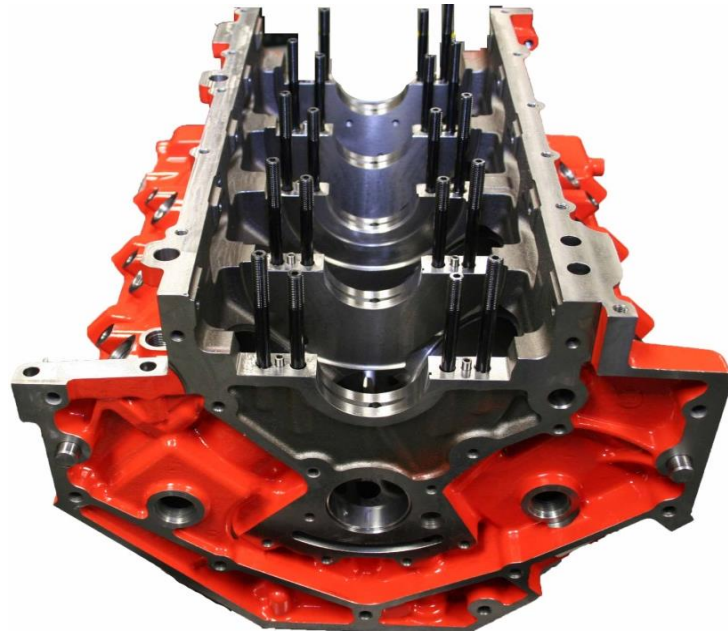

Note:

Use compressed shop air to blow through main cap oil drilled passages and main gallery oil passages to insure no materials are in oil passages after camshaft bushing installation.

Description of Operation

Check final positioning of camshaft bushings to ensure they are properly positioned between lifter bore holes.

Inspect all oil galleries for possible debris from bushing installation.
See "Note"

Measure the camshaft bearing clearances.
See Build Specification Table Section 3, Sheet 0.
Record clearances in the Data Dictionary Form 19, A.8.

Install main caps
(See Section 1 Sheet 4)
Prepare engine for final cleaning before test assembly.

Specification

REV	Date	Revision History

View	
Camshaft Bushing Inspection	
General inspection prior to cleaning after camshaft bushing installation.	

Short Block

GMOD

Section
3

Sheet
4

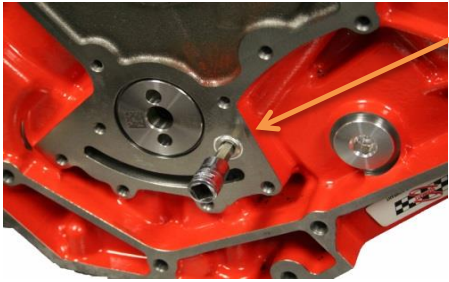

A1 Note: "A" Rear Oil Gallery Plug should be installed so that the plug is flush to no more than 0.040 inch protrusion from machined surface of block. The rear cover has a recess for this clearance. Make sure there is no interference when rear cover is bolted to block. Do not use alternate threaded plug as deeper reach plugs will protrude into cross drilled oil gallery passage.

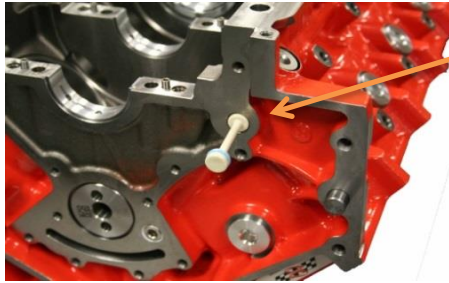

B2 Note: "B" Oil Gallery Passage Divider, (Dog Bone Shape with O-Ring) should protrude as specified below from machined surface so rear cover applies slight pressure for proper internal sealing on recessed oil gallery diameter.

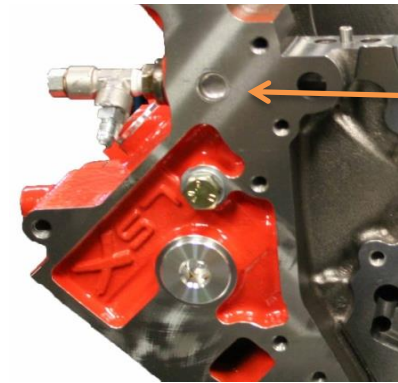
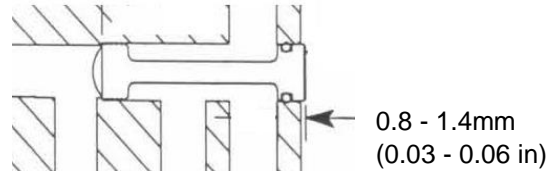

C3 Note: "C" Front Oil Gallery Cup Plug should be installed flush to slightly below machined surface of block.

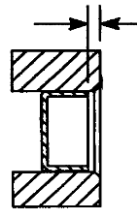

Description of Operation

All plugs described on this page are replaced every test with new parts.

A Install rear oil gallery threaded plug. (See Note: "A"). The use of #2 Permatex to seal these threads is recommended. Torque to 44 lb-ft and check protrusion in note A1.

B Install rear oil gallery plastic dog bone style passage divider (See Note: "B").

C Install front oil gallery cup plug (See Note: "C").

Specification

- 1 14090911 Plug, Oil Gallery Threaded
- 2 12573460 Plug, Oil Gallery Passage Divider
- 3 9427693 Plug Oil Gallery Cup

REV	Date	Revision History

View
Oil Gallery Plug Installation
Installation views and notes for oil gallery plug installations.

Short Block

GMOD

Section
3

Sheet
5

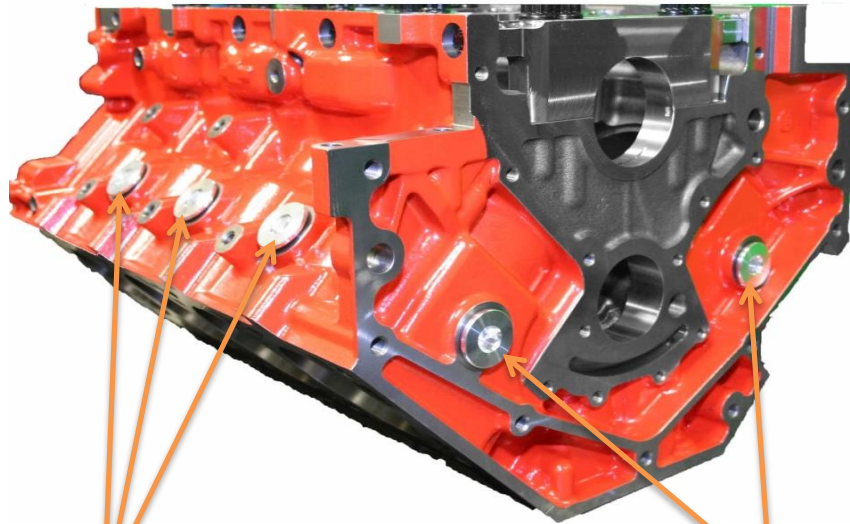

A 1

AN Core Sand Plugs
3 Each Side

A 1

AN Core Sand Plugs
2 Each Front & Back

Description of Operation

A
Install all AN type core sand plugs using new O-rings.
Tighten the core sand plugs to 11Nm (100 in lb).

Specification

- 1 AN type Plug, Core Sand
- 2 GMW395 Kit, O-ring, GMOD Test Block
or use MS92794 if plug is large size

REV	Date	Revision History

View	
Coolant Jacket Core Plugs	

Short Block

GMOD

Section
3

Sheet
6

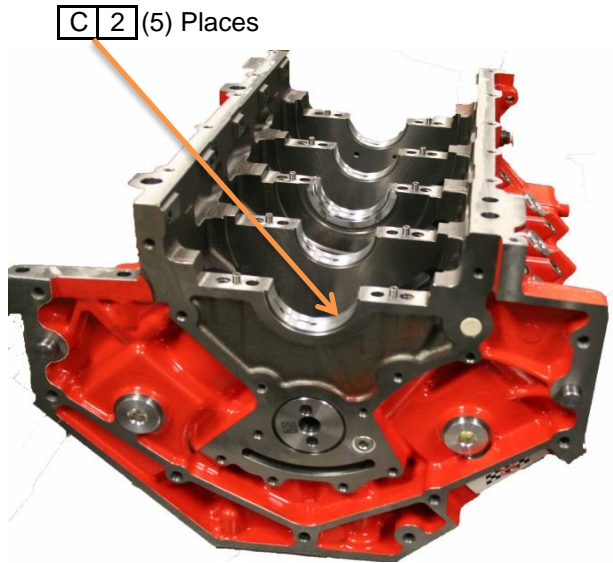

- OHT GMOD Bearing Kit
- OHTGMOD001-1 Bearing, Connecting Rod (16 Ea.)
 - OHTGMOD001-2 Bearing, Crankshaft, Upper (4 Ea.)
 - OHTGMOD001-3 Bearing, Crankshaft, Lower (4 Ea.)
 - OHTGMOD001-4 Bearing, Crankshaft, Thrust, Upper (1 Ea.)
 - OHTGMOD001-5 Bearing, Crankshaft, Thrust, Lower (1 Ea.)
 - OHTGMOD001-6 Bushing, Camshaft, High Performance (5 Ea.)

Description of Operation

- A The camshaft is usable for up to six runs. The camshaft should be visually inspected for evidence of frosting or distress on the lobes between each test.
- B Lubricate the camshaft with EF-411 assembly lube and install the camshaft.
- C Install the upper main bearing shells
- X Lubricate with EF-411 assembly lube.

Specification

- 1 12625437 Camshaft
- 2 Bearing, upper part of OHTGMOD 001

REV	Date	Revision History
Short Block		GMOD

View	
Camshaft & Upper Main Bearings	
Section	Sheet
3	7

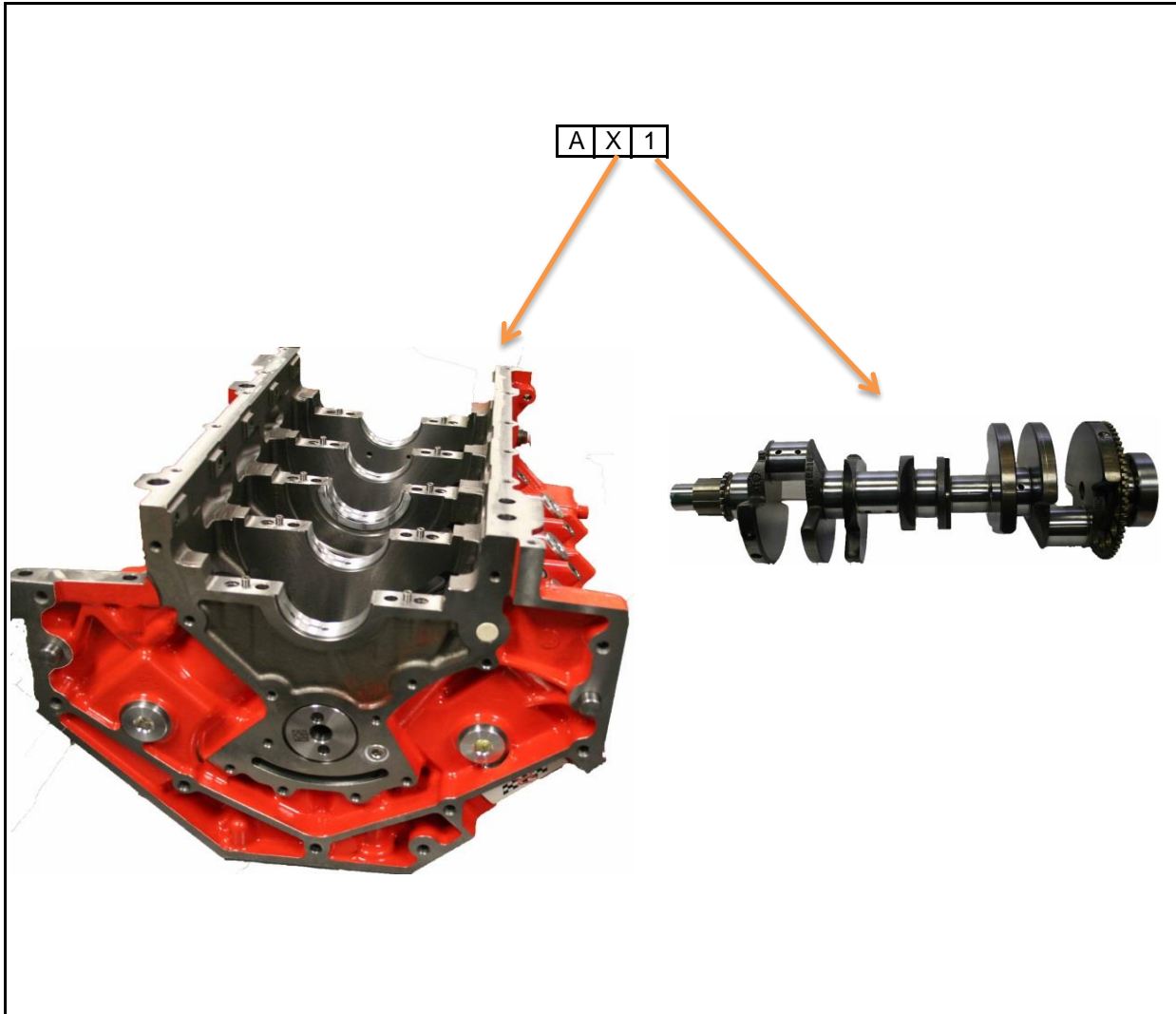

Description of Operation

A Crankshafts are allowed to be used for up to 6 runs or less if they do not meet recommended service specifications.

Note: No special conditioning of crankshafts are allowed. No cleaning with abrasive materials is permitted.

Record main bearing clearances on GMOD Engine Build Data Form 19.

X Lubricate all bearings and journals with EF-411 during final assembly.

Specification

1 12588612 Crankshaft
Special order through Chevy Performance

REV	Date	Revision History
Short Block		GMOD

View	
Crankshaft Installation	
Section	Sheet
3	8

A B C D

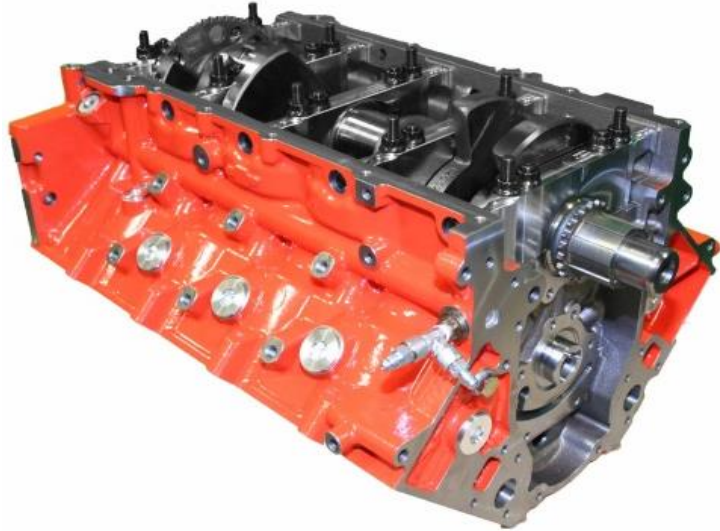

Note: If using a new crankshaft, install the crankshaft key and timing chain / oil pump drive gear to the crankshaft using Kent Moore installation tool J-41665-1A



Note: 1) After operation B has been completed, run all nuts down snug with a speed handle. Lightly tap the crankshaft Fore & Aft to position the thrust bearing for clearance measurement.

Bolt Torque Sequence

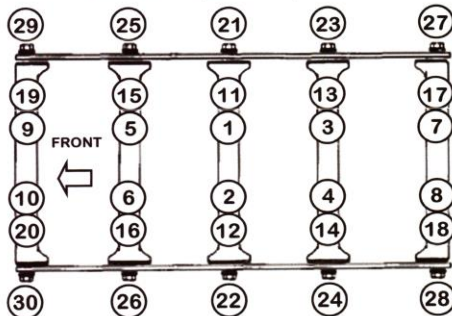

Outer Studs 4.55 long Nuts 50 ± 2 lb.ft.
Inner Studs 4.77 long Nuts 60 ± 2 lb.ft.

M8 side bolts 20 ± 2lb.ft. (with #2 Permatex under head)

Description of Operation

- A Coat all studs with EF-411

Install studs "hand tight" with speed handle. Follow torque specification chart for final application.
- B Note: 1) To ensure caps are fully seated in block, apply 20 ± 2 lb.ft. torque on inner stud nuts following crisscross pattern. Loosen nuts, back off three to four threads. Hold nut with finger while tightening stud to 100 ± 10 inch pound to ensure stud is fully bottomed in block.

Follow torque sequence in chart for final application. Apply #2 Permatex sealer under head of side bolts.
- D Thrust Clearance (0.0015 - 0.0078 in.)

Record main bearing clearance on GMOD Engine Build Data Form 19.

Specification

- 1 234-5608 Kit Stud, ARP
- 2 12375821 RTV Sealant
- 3 OHTGMOD001-2 Bearing Upper (4)
- 4 OHTGMOD001-3 Bearing Lower (4)
- 5 OHTGMOD001-4 Bearing Thrust Upper
- 6 OHTGMOD001-5 Bearing Thrust Lower
- 7 12556582 Sprocket, Crankshaft
- 8 12561513 Key Crankshaft

Revision History

REV	Date	Revision History

View

Main Cap & Bearing Installation
Main Bearings, Crankshaft, Main Caps with Studs, and Crankshaft end play clearance check.

Short Block

GMOD

Section
3

Sheet
9

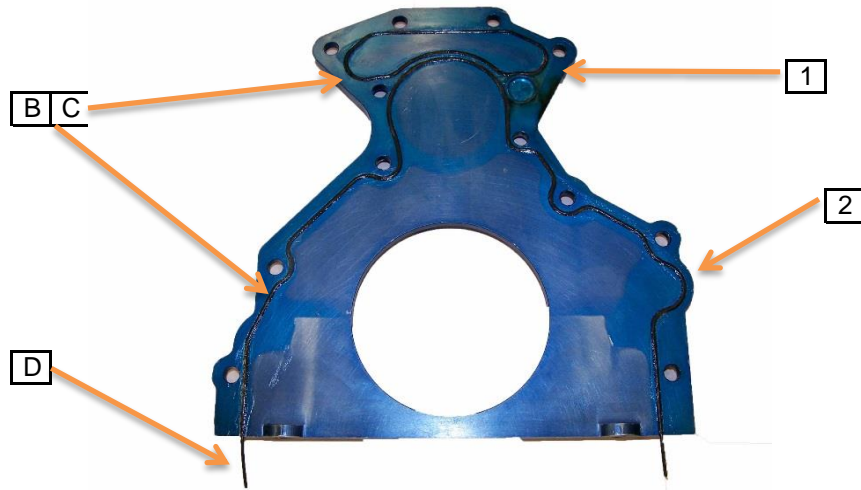
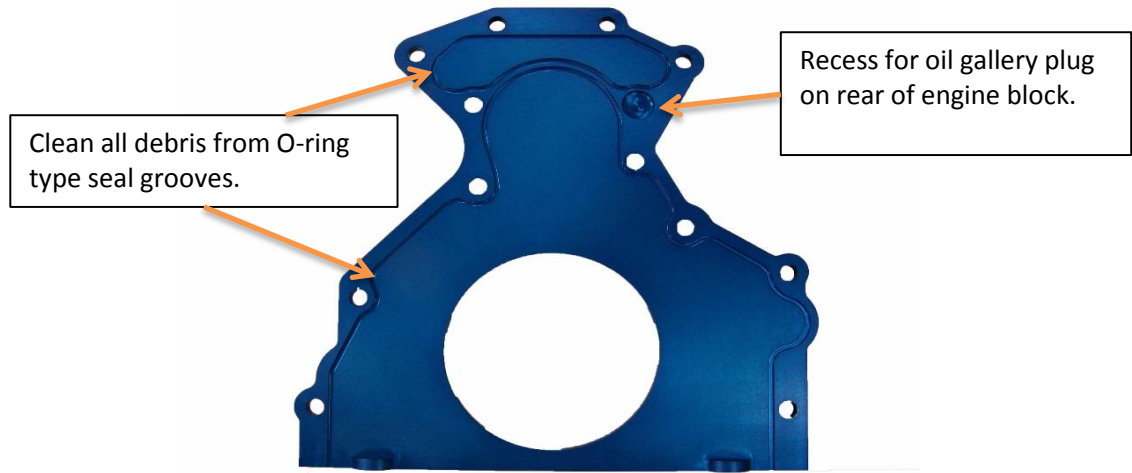

Description of Operation

- A Clean rear cover to remove any residue from previous test. Pay specific attention to seal areas for O-ring type seals.
- B Apply a very small bead of Petroleum Jelly to the grooves for both O-ring type seals. Use a plastic scraper to remove excess.
- C Install the O-rings following the grooves with finger pressure. Remove any excess Petroleum Jelly with a plastic scraper and clean shop towel.
- D Leave excess seal protruding from bottom of cover. Excess seal will be trimmed after cover installation.

Specification

- 1 OHTGMOD 201-1 Seal Short, Rear Cover
- 2 OHTGMOD 202-2 Seal Long, Rear Cover

REV	Date	Revision History
Short Block		GMOD

View	
Rear Cover Seal	
Rear cover cleaning and O-ring seal installation.	
Section	Sheet
3	10

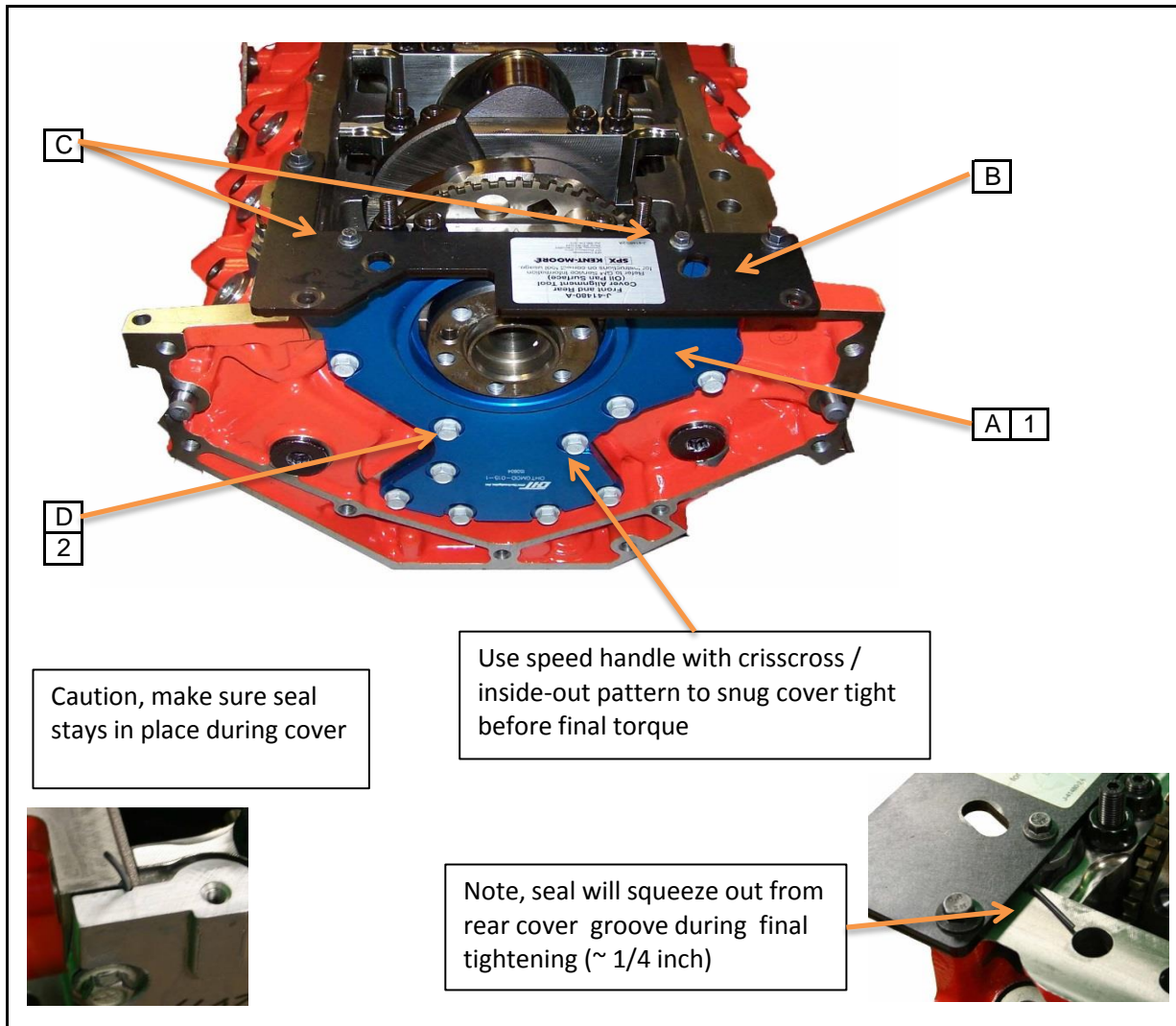

Description of Operation	
A	Carefully position the rear cover onto the block without dislodging the seals and draw the fasteners snug by hand, (cover must be able to move slightly during final alignment).
B	Attach Kent Moore J-41480-A to the oil pan rail of the engine block using caution to avoid pinching the seals protruding from the bottom of the rear cover.
C	Install two fasteners through the Kent Moore tool into the bottom of the rear cover and draw snug to position the rear cover.
D	Tighten the rear cover fasteners to 18 ± 2 lb. ft. and cut off the excess seal length.

Specification	
1	OHTGMOD-015-1 Cover, Rear
2	11588723 Bolt, Rear Cover

REV	Date	Revision History
Short Block		GMOD

View	
Rear Cover Installation	
Section	Sheet
3	11

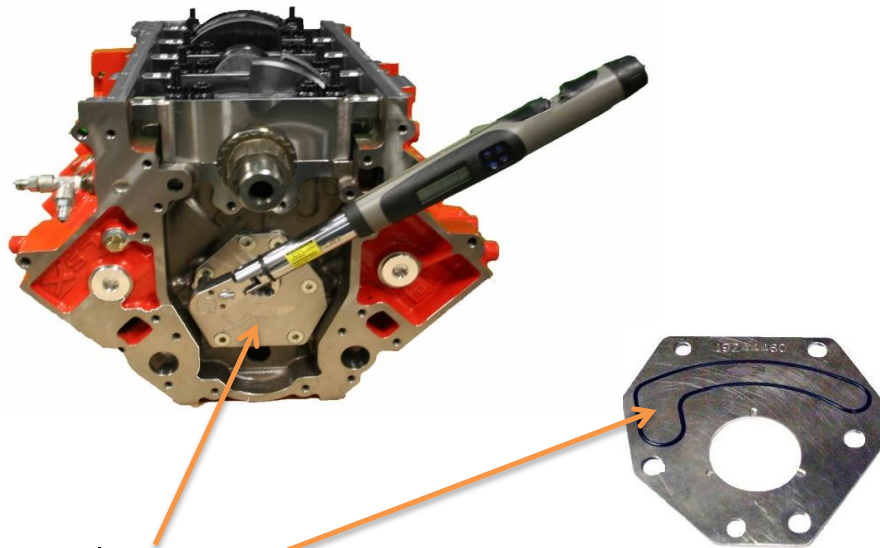

A	B	C
1	2	3

Description of Operation

- A Install oil transfer gallery O-ring seal on rear of camshaft thrust plate using a small amount of Petroleum Jelly.
- B Carefully position the camshaft thrust plate to the engine and secure with (6) Screw type fasteners.
- C Torque the screw type fasteners to 11 ± 1 lb.ft.

Specification

- 1 19244460 Plate, Camshaft, Thrust
- 2 OHTGMOD 200-1 Seal, Thrust Plate
- 3 11561455 Screw, Camshaft Thrust Plate

REV	Date	Revision History

View	
Camshaft Thrust Plate	
Camshaft Thrust Plate attachment.	

Short Block

GMOD

Section
3

Sheet
12

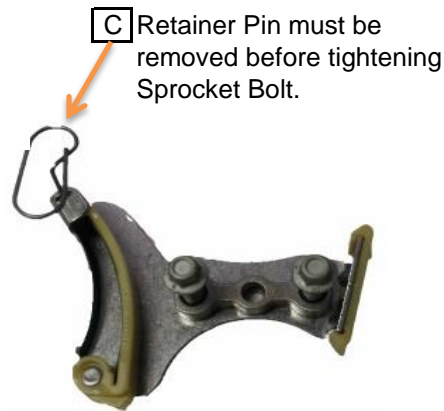
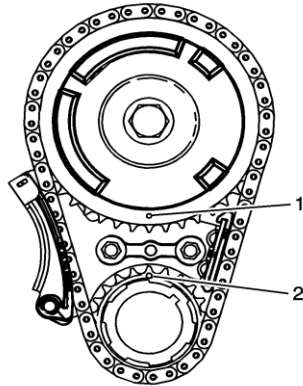
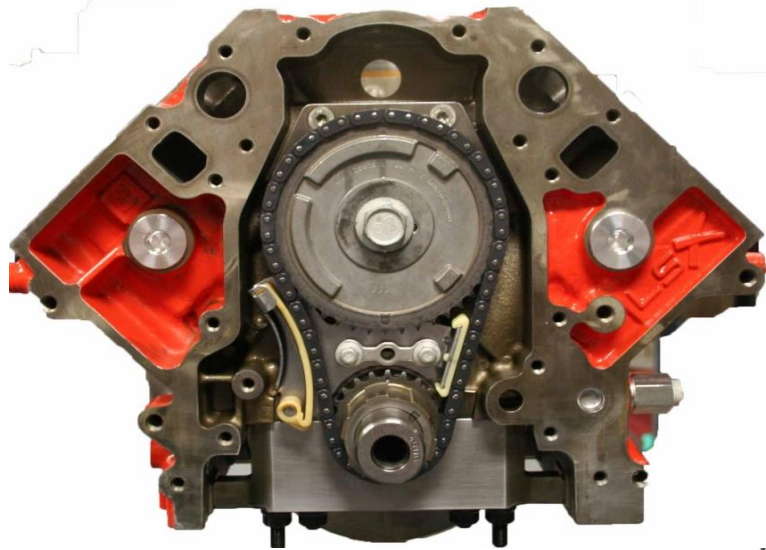

Description of Operation

- A Install the timing chain tensioner assembly and torque the fasteners to 22 ± 2 lb.ft.
- B Align the markings on the crankshaft timing chain drive gear and the markings on the camshaft sprocket together and install the chain and sprocket assembly, positioning the camshaft so everything is in alignment. Ref. 1 & 2 in drawing
- C Install the camshaft sprocket bolt and tighten to hold the assembly snug. Remove the camshaft tensioner retainer pin.
- D Using a holding device, hold the crankshaft from turning while tightening the camshaft sprocket bolt to 55 ± 2 lb.ft. + 50° .
- E Measure the camshaft endplay. See specification Section 3 sheet 0. Record in Data Dictionary Form 19, A.5.

Specification

- 1 12626407 Tensioner, Timing Chain w/Bolts
- 2 12591689 Sprocket, Camshaft Timing
- 3 12646386 Chain Timing
- 4 11561283 Bolt, Camshaft, Sprocket

REV	Date	Revision History

View	
Timing Chain Assembly	
Installation of the timing chain assembly	

Short Block	GMOD
--------------------	-------------

Section	Sheet
3	13

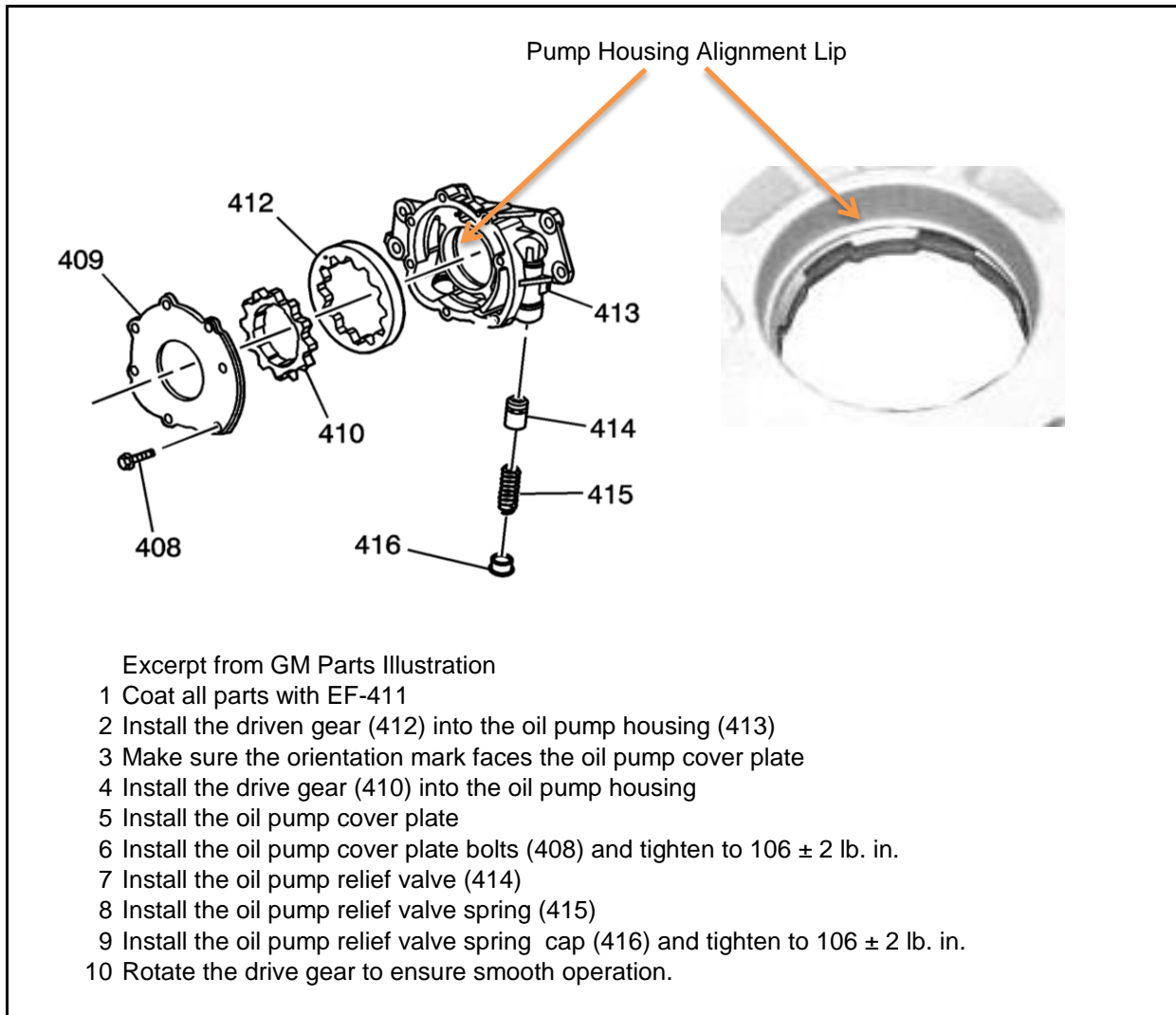

Description of Operation

Engine oil pump assembly
 The oil pump assembly is allowed to be used for a maximum of 4 6 runs or less .

Oil pump assemblies must be disassembled, cleaned and inspected before each test.
 Coat all parts with EF-411

Note: Pump housing must be inspected for excessive wear on the alignment lip that pilots off the inner gearrotor gear (410) to properly align the pump housing during installation.

Specification

1 12586665 Pump, Oil, Assembly Kit
 Parts not serviced separately

REV	Date	Revision History
Short Block		GMOD

View	
Oil Pump Assembly	
Section	Sheet
3	14

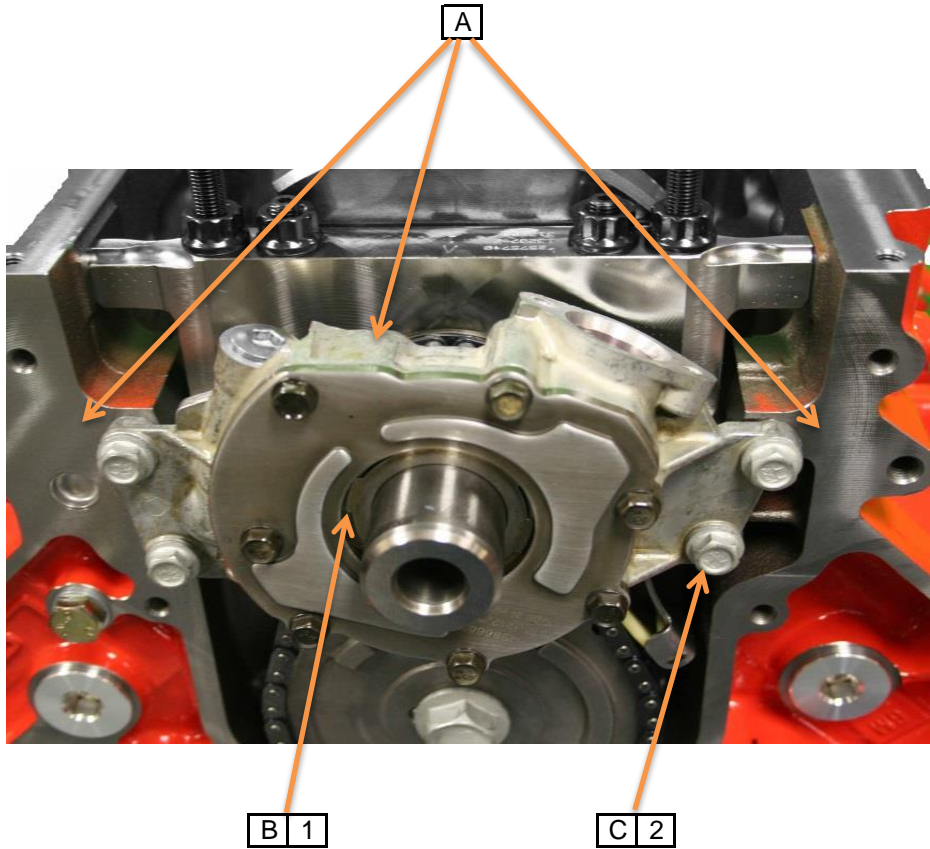

Description of Operation

- A Closely inspect the mating areas of the engine block and the oil pump to ensure they are clean.
- B Install the oil pump assembly by aligning the splined surfaces of the crankshaft sprocket and the oil pump drive gear. Install the oil pump until the pump housing firmly seats itself against the face of the engine block.
- C Install all four fasteners and while pushing upwards on the pump housing hand tighten with a speed handle. Torque the fasteners to 18 ± 2 lb. ft. Note: Make sure bolt holes are clean and allow fastener to torque against oil pump housing. Position assembly so the inner gear is centered without any side loading to position housing properly. See Section 3 Sheet 14

Specification

- 1 12586665 Pump Assembly, Oil
- 2 11515758 Bolt, Oil, Pump, Housing (4)

REV	Date	Revision History
Short Block		GMOD

View	
Oil Pump Installation	
Oil Pump Installation	
Section	Sheet
3	15

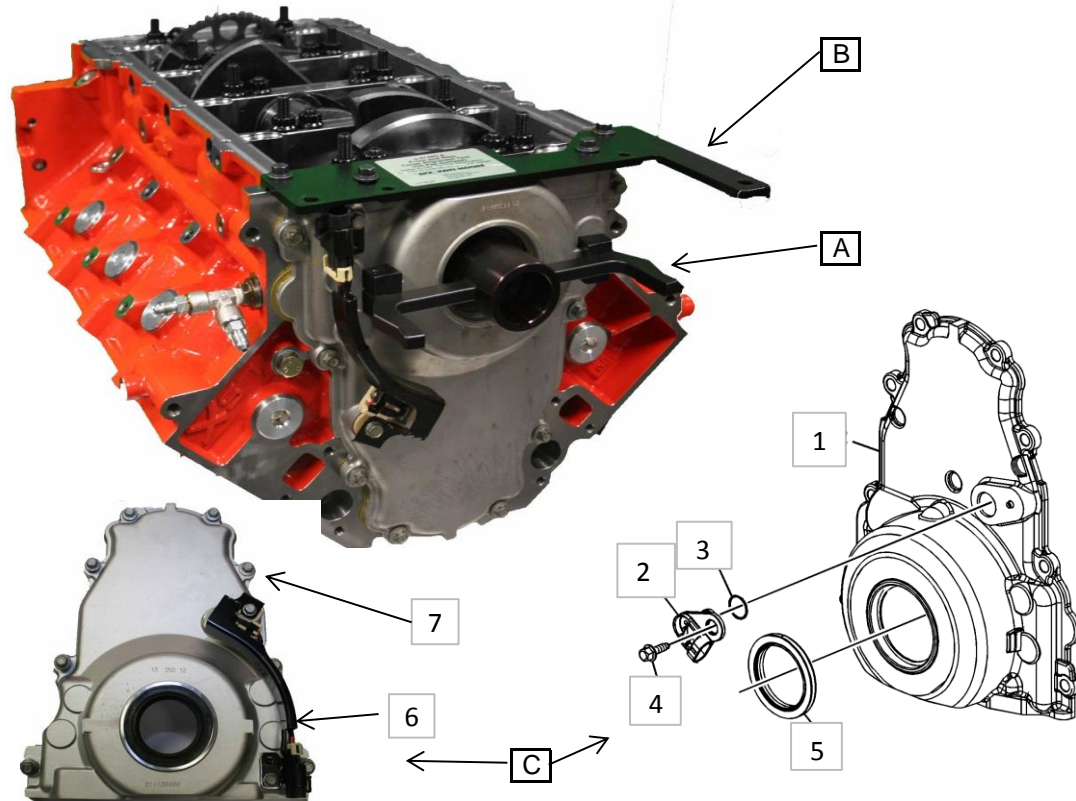

Front Cover Assembly 12633906 includes bolts, gasket, seal, and camshaft sensor with connector

Note: Balancer seal must be removed for proper alignment with Kent Moore Tools when part is purchased as assembly

Description of Operation

- A Kent Moore special front cover alignment installation tool J-48853
 - B Kent Moore special front cover to oil pan rail alignment tool J-41480-A
 - C Front cover sub assembly components.
 - 1 Install front cover with gasket and fasteners, finger tight.
 - 2 Install Kent Moore J-41480 (A) to oil pan rail and bottom of front cover with two fasteners in each and tighten finger tight .
- Note: All fasteners should only be finger tight and all components should be free to move until final alignment process.

Specification

- 1 12600326 Cover Front
- 2 12591720 Sensor Cam. Position w/seal
- 3 O-ring Seal, part of 12591720
- 4 11588712 Bolt Camshaft Sensor
- 5 12585673 Seal, Crankshaft Balancer
- 6 12627501 Sensor, Wire Assembly
- 7 11515758 Bolt, Front Cover
- 8 12633904 Gasket Ft. Cover (Not Shown)

REV	Date	Revision History
Short Block		GMOD

View	
Front Cover	
Front Cover Sub Assembly with Kent Moore specialty tools.	
Section	Sheet
3	16

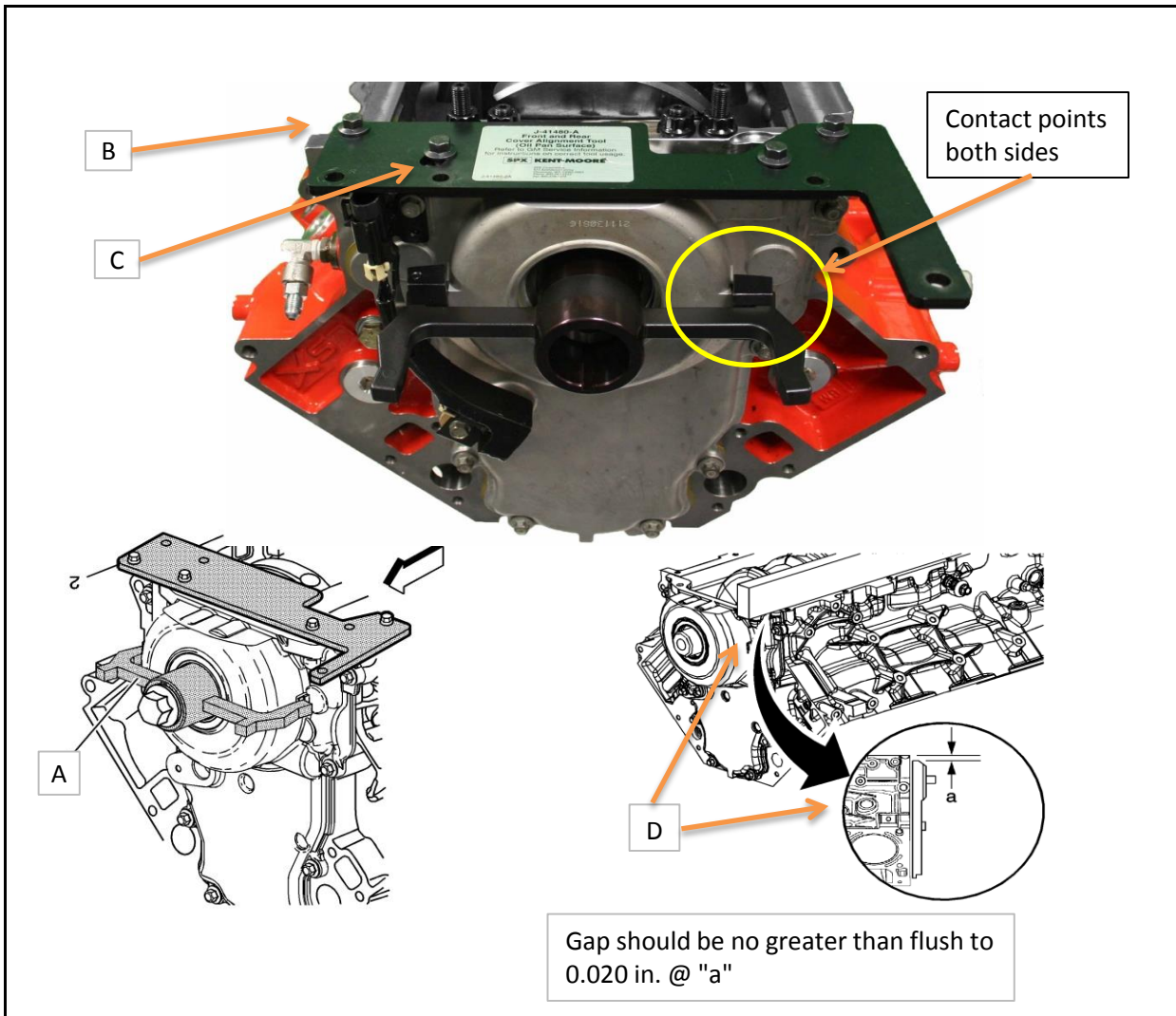

Description of Operation	
A	Install Kent Moore front cover alignment tool J-48853. Tighten the balancer bolt snug by hand until the tool contacts the centering contacts either side of front seal on front cover.
B	Tighten the two fasteners on the oil pan rail at the rear of Kent Moore J-41480-A alignment tool.
C	Snug the two fasteners threaded into the bottom of the front cover to draw the cover snug against the Kent Moore positioning tool.
	Tighten the front cover bolts to 22 ± 2 lb. ft.
D	Check height between pan rail and front cover using straight edge.

Specification	

REV	Date	Revision History
Short Block		GMOD

View	
Front Cover Installation	
Alignment and tightening procedure for front cover.	
Section	Sheet
3	17

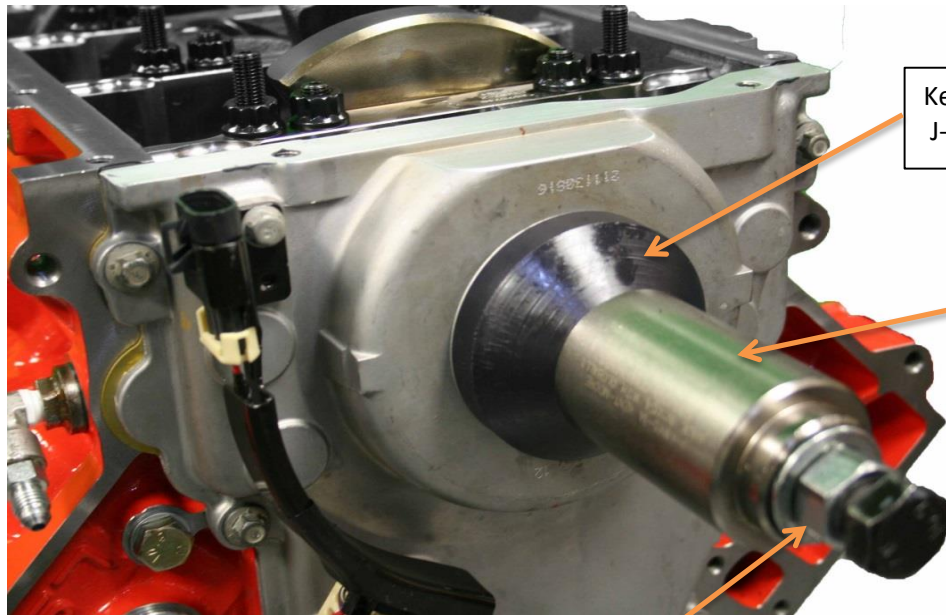

Kent Moore
J-41478-1A

Kent Moore
J-41665-1A

Position installation tools with seal square to front cover drawing snug with bolt threaded into crankshaft. Push seal into front cover using nut on J-41665-1A

Description of Operation

Install front seal using Kent Moore tools J-41478-1A and J-41665-1A.

Note: Do not use oil on ID of front seal.

Install seal on Kent Moore J-41478-1A. Apply light coat of EF-411 on outside diameter of seal.

Align seal and Kent Moore J-41478-1A square to front cover. Using Kent Moore tool J-41655-1A, thread bolt into crankshaft until tools are snug. Install seal using Nut on J-41655-1A until firmly seated in front cover.

Specification

1 12585673 Seal, Crankshaft, Balancer
(Seal not viewable in photo)

REV	Date	Revision History

View	
Front Balancer Seal Installation	

Short Block

GMOD

Section
3

Sheet
18

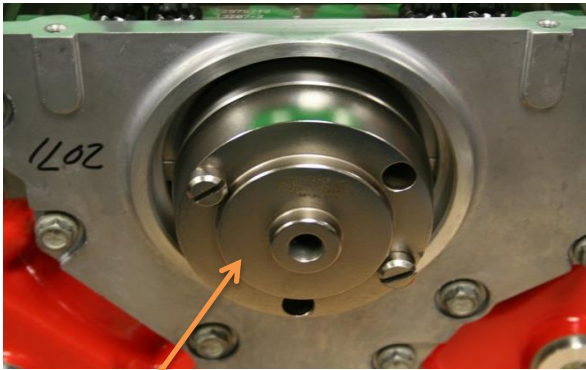

Kent Moore
J-41479-2B



1 Seal with Shipping Protector
Caution; Seal is reverse lip technology, blocking crankcase breathers during blowby measurement may cause oil leakage.

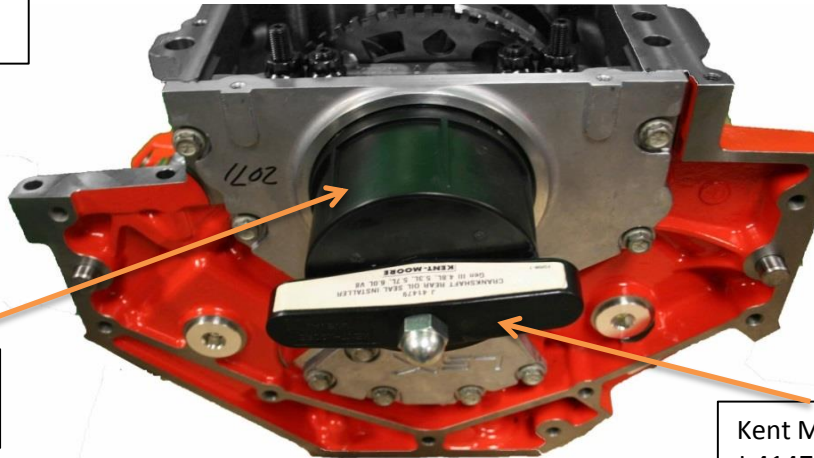

Kent Moore
J-41479-1

Kent Moore
J-41479

Description of Operation

Do not lubricate ID of crankshaft seal.

1. Lubricate the OD of the rear seal with a light coat of EF-411.
2. Lubricate the bore in the rear cover with a light coat of EF-411.
3. Install J-41479-2B cone onto the rear of the crankshaft and tighten snug with straight slot screws.
4. Install the rear oil seal onto the tapered cone and gently push the seal square to the rear cover.
5. Thread J-41479 with J-41479-1 into the tapered cone until the tool contacts the rear seal.
6. Align the tool and rear oil seal square with the seal and rear cover.
7. Rotate the handle on the tool clockwise to install the seal into the rear cover until the seal bottoms into the rear cover.

Specification

1 89060436 Seal, Crankshaft, Rear

REV	Date	Revision History
Short Block		GMOD

View	
Rear Crankshaft Seal	
Installation of rear crankshaft lip seal.	
Section	Sheet
3	19



View A



Tool orientation to start balancer on crankshaft

View B



Tool orientation to install balancer on crankshaft

Balancer Installation

- 1) Install crankshaft holding fixture (in-house fabricated).
- 2) Use Kent Moore tool configured as shown in view A to start balancer and push balancer ~ 1/4" onto crankshaft.
- 3) Remove Kent Moore tool and reposition as shown in view B to install balancer until fully positioned against crankshaft sprocket.
- 4) Using a used balancer bolt, tighten the balancer bolt to 240 lb.ft. and then remove the bolt to check for proper clearance between the front of the balancer and the nose of the crankshaft. (View D)
- 5) If there is insufficient clearance, remove balancer and inspect all parts to determine cause. Select washers are available through service parts. Contact test sponsor for further information.
- 6) Install a new crankshaft balancer bolt and tighten to 110 lb.ft.
- 7) Loosen the crankshaft balancer bolt 360°
- 8) Tighten the crankshaft balancer bolt to 59 ± 2 lb.ft.
- 9) Tighten the crankshaft balancer bolt a final pass to 125°

Note: Labs may hone the ID of the balancer to make it a slip fit. Clearance between the crankshaft OD and the balancer ID should not

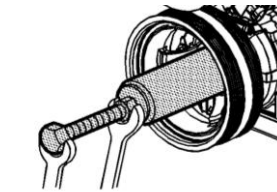

View C

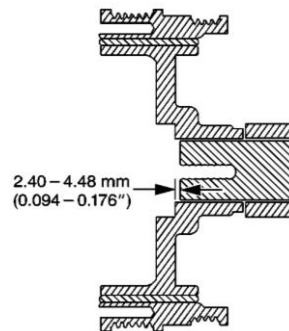

View D

Description of Operation

- A Kent Moore J 41665 Crankshaft Balancer and Sprocket Installer configured for initial balancer alignment.
- B Kent Moore J 41665 Crankshaft Balancer and Sprocket Installer configured for final balancer installation.
- C Balancer installation using Kent Moore tooling.
- D Balancer to crankshaft clearance check, must be (0.094 - 0.176 inch).

Labs may hone balancer for slip fit, however, clearance must be checked and proper torques applied.

Specification

- 1 12557840 Bolt, Balancer
- 2 12634105 or 19300488 Balancer, Harmonic

REV	Date	Revision History
Short Block		GMOD

View	
Balancer Installation	
Install balancer as outlined in "Balancer Installation" Text Box. Read all information contained on this page for proper installation.	
Section	Sheet
3	20

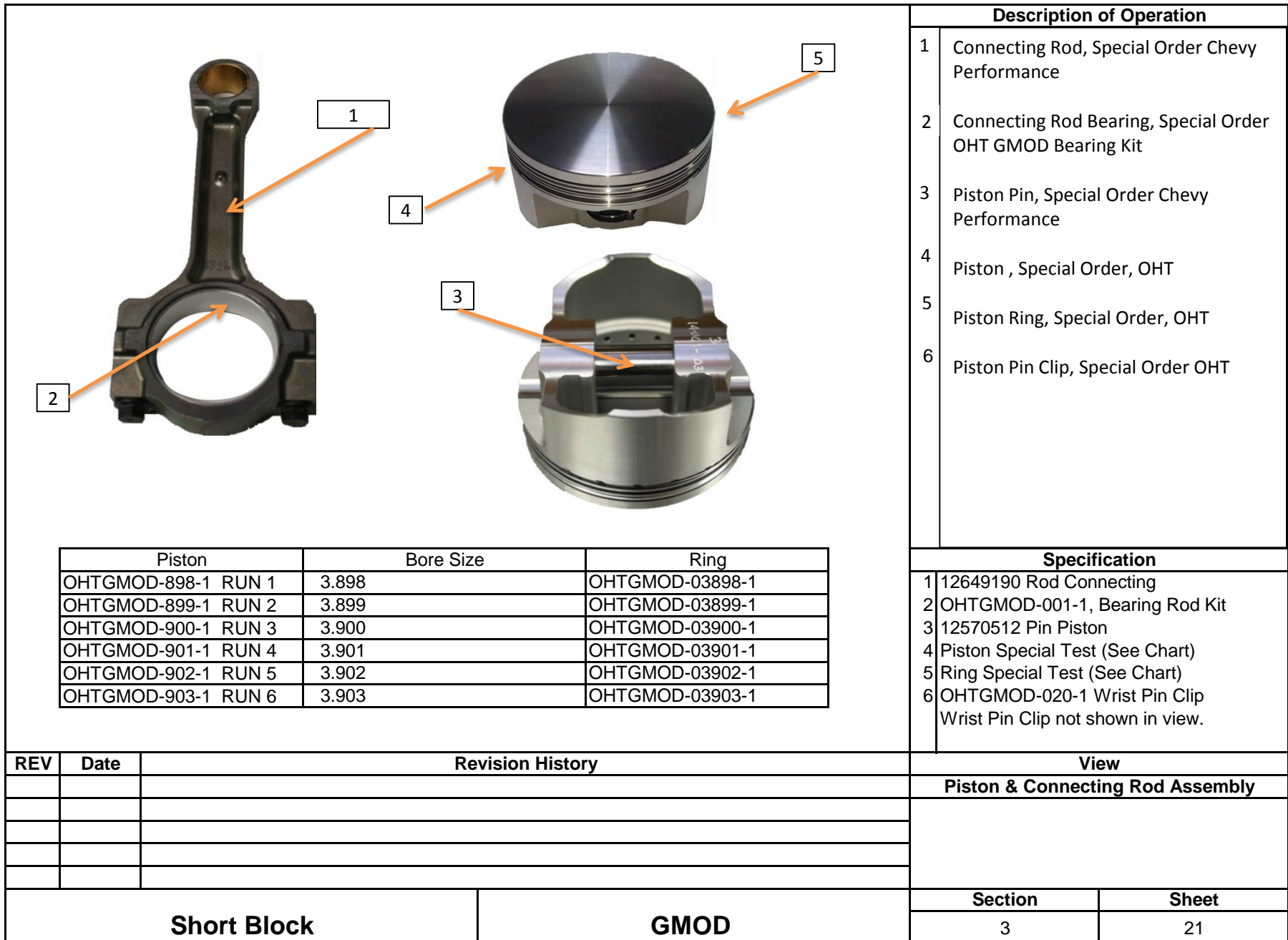

Description of Operation	
1	Connecting Rod, Special Order Chevy Performance
2	Connecting Rod Bearing, Special Order OHT GMOD Bearing Kit
3	Piston Pin, Special Order Chevy Performance
4	Piston , Special Order, OHT
5	Piston Ring, Special Order, OHT
6	Piston Pin Clip, Special Order OHT

Piston	Bore Size	Ring
OHTGMOD-898-1 RUN 1	3.898	OHTGMOD-03898-1
OHTGMOD-899-1 RUN 2	3.899	OHTGMOD-03899-1
OHTGMOD-900-1 RUN 3	3.900	OHTGMOD-03900-1
OHTGMOD-901-1 RUN 4	3.901	OHTGMOD-03901-1
OHTGMOD-902-1 RUN 5	3.902	OHTGMOD-03902-1
OHTGMOD-903-1 RUN 6	3.903	OHTGMOD-03903-1

Specification	
1	12649190 Rod Connecting
2	OHTGMOD-001-1, Bearing Rod Kit
3	12570512 Pin Piston
4	Piston Special Test (See Chart)
5	Ring Special Test (See Chart)
6	OHTGMOD-020-1 Wrist Pin Clip Wrist Pin Clip not shown in view.

REV	Date	Revision History

View	
Piston & Connecting Rod Assembly	

Short Block		GMOD	
-------------	--	------	--

Section	Sheet
3	21

Top Rings		Second Rings	
Run #	Color Code	Run #	Color Code
1	One Pink Stripe	1	One Yellow Stripe
2	Two Pink Stripes	2	Two Yellow Stripes
3	Three Pink Stripes	3	Three Yellow Stripes
4	One Purple Stripe	4	One Green Stripe
5	Two Purple Stripes	5	Two Green Stripes
6	Three Purple Stripes	6	Three Green Stripes



Description of Operation

A Confirm correct ring grade and gaps for the engine run/piston grade.

Using a Piston Ring Locating Tool, position each ring $1 \pm \frac{1}{4}$ inch below the deck of the engine block. Using the Starrett Taper Gage, measure and record the top and second piston ring gaps. Keep all rings mated with the appropriate cylinder. Record all individual piston ring gap information in the engine build data packet.

Note: No adjustments to the pre-gapped piston rings are allowed.

Target Ring Gaps

Top Ring Gap 0.019"
 2nd Ring Gap 0.032"
 All piston ring gaps to be +/- 0.002"

Specification

1 Starrett No 270 tapered gage

REV	Date	Revision History

View	
Ring Gap Measurement	
Piston ring gap data measurement.	

Short Block

GMOD

Section
3

Sheet
22

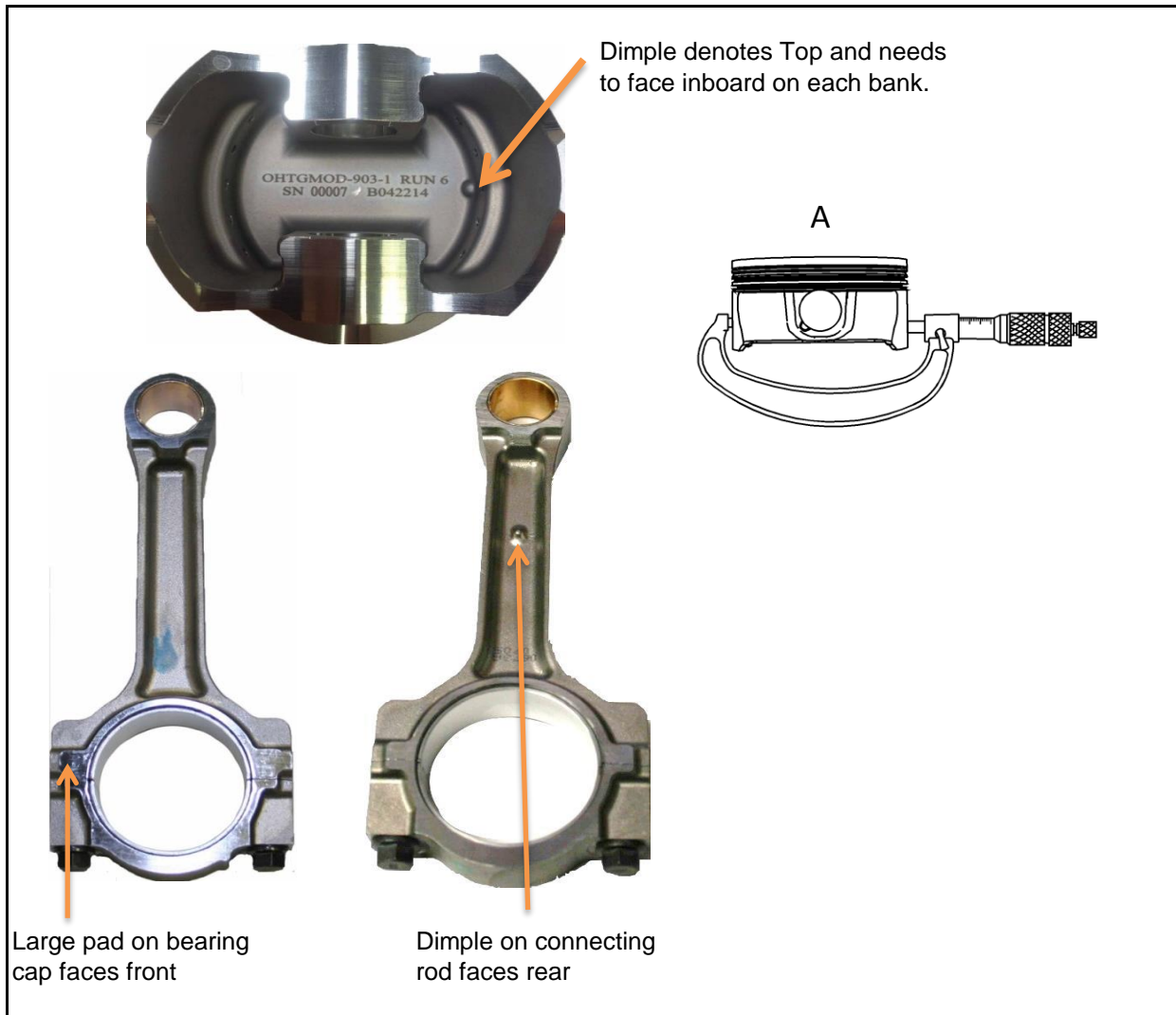

Description of Operation

A With a micrometer at a right angle, measure the piston outside diameter (OD). Measure the diameter 43 mm (1.69 in) from the top of the piston. Record the piston skirt diameter in the Data Dictionary Form 18, A.2.

B Lightly lubricate the piston and connecting rod pin bores with EF-411

C Install the piston pin, connecting rod, and piston pin clips. The retainer clips should be seated in the grooves of the piston pin bore.

D Note: Make sure the large tab on the connecting rod faces front and the dimple on the underside of the piston is positioned inboard on each bank. **(Dimple on connecting rod will be facing rearward)**

E Separate the connecting rod cap and install the engine bearing set. Lightly lube under the head and on the threads of the cap bolts.
Note: Rods are cracked parting lines and will only fit one direction, do not mix rods & caps.

REV	Date	Revision History
Short Block		GMOD

Piston Measurement & Piston & Rod Orientation	
Section	Sheet
3	23

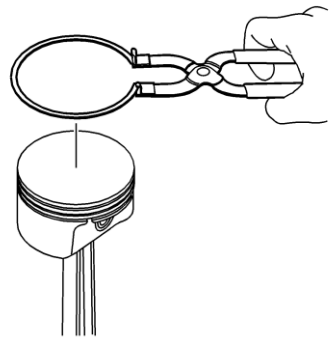

B

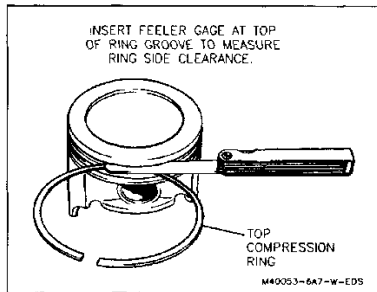

Figure 89 - Measuring Piston Ring Side Clearance

C

Note:

When installing piston rings, use a ring expander plier type tool. Do not roll the rings into the grooves of the piston. Use caution and care to expand the rings only slightly larger than the outside diameter (OD) of the piston.

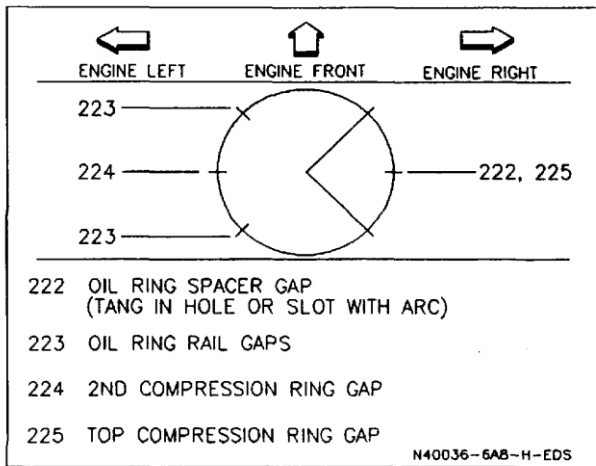

Figure 64 - Piston Ring Gap Location

D

Position the oil control ring end gaps a minimum of 1 inch from each other. Position the compression ring end gaps 180 degrees opposite each other.

Description of Operation

- A** Remove the paint marks from the rings
- B** Check the ring side clearance.
Top and Second 0.001" to 0.003"
(0.025 mm - 0.076 mm)
Oil: 0.001" to 0.008"
- C** (0.025 mm - 0.203 mm)
Using piston ring pliers, install the piston rings onto the piston. The dimple or mark on the piston ring should face the top of the piston. If no dimple or mark can be found on the top compression ring, it may be installed in either direction. The second compression ring must be positioned with the dimple or mark to the top. This corresponds to the larger diameter of the taper face positioned toward the bottom of the piston.
- D** Position the ring end gaps as shown

Specification

REV	Date	Revision History

View	
Piston Ring Installation	

Short Block

GMOD

Section
3

Sheet
24

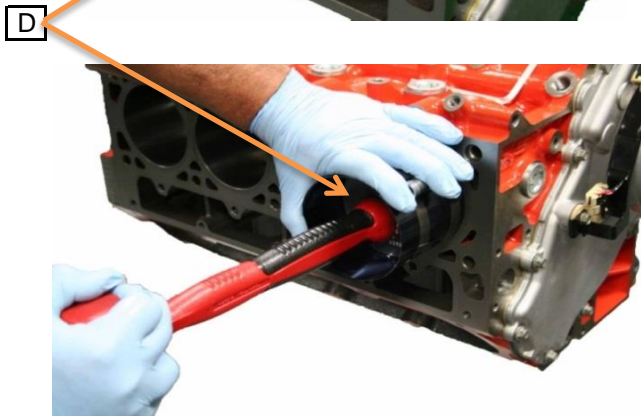
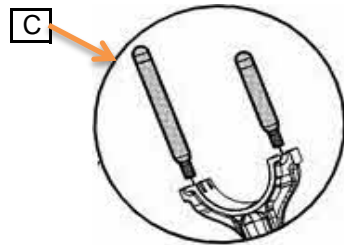
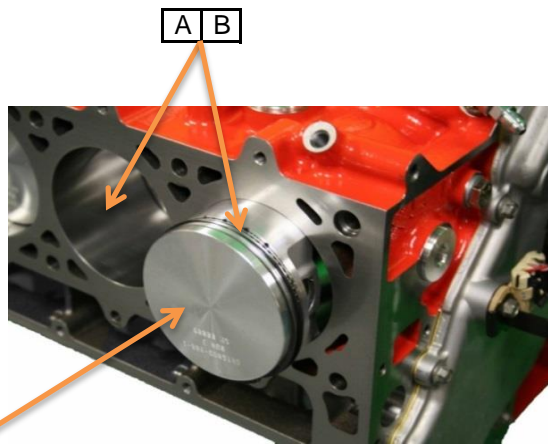

Text Box E
 Use caution to insure piston rings, rails, & expander are seating properly during compression using Kent Moore J-8037 Ring Compressor. Install the piston assembly into the cylinder bore aligning the connecting rod to the crankshaft. Lightly tap the piston ring compressor to insure it is properly seated against the cylinder deck. Using a plastic dead blow hammer handle, see view, lightly tap the piston assembly until all of the piston rings have entered the cylinder. After checking for proper alignment, gently tap the piston assembly until it seats the connecting rod & bearing into position. Remove Kent Moore J-41556 guides, oil the crankshaft with EF-411 and install the connecting rod cap with bearing. Use a speed handle and socket to seat the rod cap fasteners.

Description of Operation

- A Clean cylinder bores with lint free cloth and EF-411.
- B Lubricate piston, rings, cylinder bore, and connecting rod bearings with EF-411.
- C Install connecting rod guides, Kent Moore J-41556 has been found acceptable, to the connecting rod.
- D Insert piston into bore making sure connecting rod is properly lined up with the crankshaft journal and the piston assembly is properly facing front and top as outlined in Section 2 Sheet 22.
- E Use a piston ring compressor and follow instructions in text box "E"

Specification

REV	Date	Revision History

View	
Piston Installation	

Short Block	GMOD	Section	Sheet
		3	25



Tighten connecting rods in sequence
Two steps:
1) Torque
2) Angle

Check clearance for each journal set; gage between rods and crank journal.

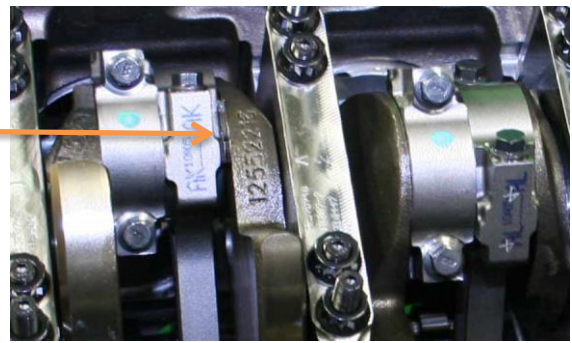

Description of Operation

- A Lubricate each connecting rod / crankshaft journal and align each connecting rod cap correctly. Use a speed handle to snug each fastener. Once all eight pistons have been installed, tighten the connecting rods in sequence in two steps.
- B 1) Torque all fasteners to 15 ± 1 lb.ft.
2) Tighten all fasteners an additional $85^\circ \pm 2^\circ$
- C Check and record the clearance for each rod bearing set . Check and record the side clearance between each journal set and crankshaft. Side clearance should be between 0.0043 to 0.020 inches.
Record all clearance data on GMOD Form 18.

Specification

REV	Date	Revision History
Short Block		GMOD

View	
Connecting Rod Torque	
Connecting rod torquing and clearance checking.	
Section	Sheet
3	26

Description of Operation

The windage tray has two fastener positions needing modification.

Two positions are slotted holes. Using an appropriate device, modify the slotted opening making it larger to receive the ARP Main Cap Fastener Stud for the areas identified in the view.

Oval Slot Modifications



Specification

1 12611129 Deflector, Crankshaft, Oil (Windage Tray)

REV	Date	Revision History

View

Windage Tray Modification

Section

3

Sheet

27

Short Block

GMOD

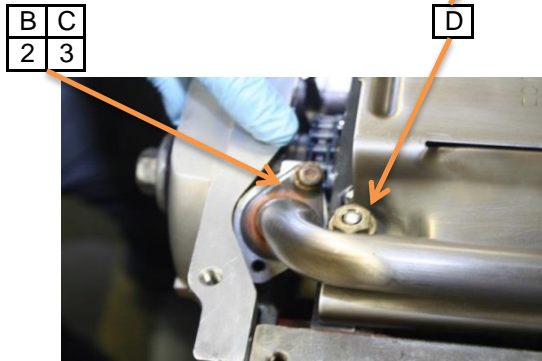
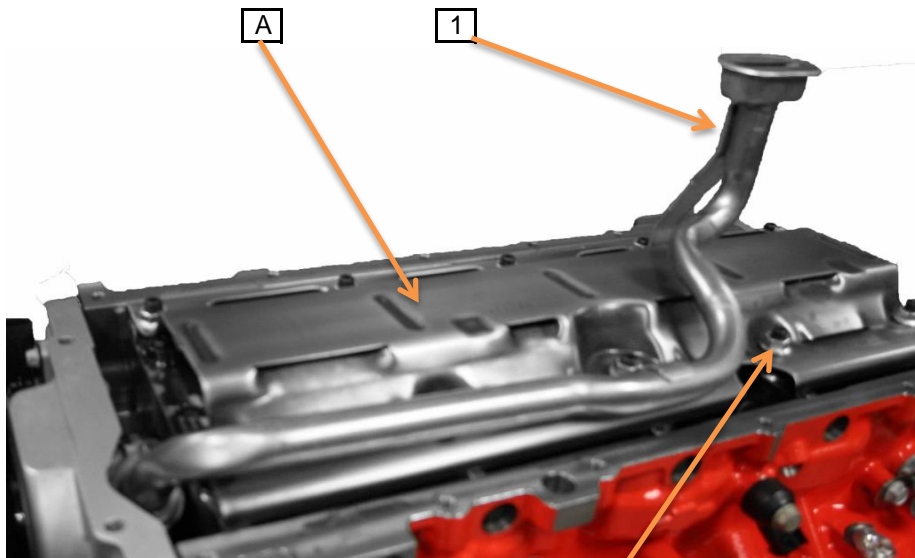

Description of Operation

- A Install the windage tray and snug using a couple of fasteners on the outside edges.
- B Install the oil pickup tube assembly using a new O-ring
- C Torque the oil pickup tube to the oil pump housing to 106 ± 2 lb.in.
- D Torque the fasteners on the windage tray and oil pickup tube supports to 18 ± 2 lb.ft.

Specification

- 1 12608579 Tube, Oil, Pickup w/O-ring
- 2 12584922 Seal, O-ring (Not Shown)
- 3 11519133 Bolt, Pickup, Tube

REV	Date	Revision History

View	
Windage Tray & Pickup Tube	

Short Block

GMOD

Section
3

Sheet
28

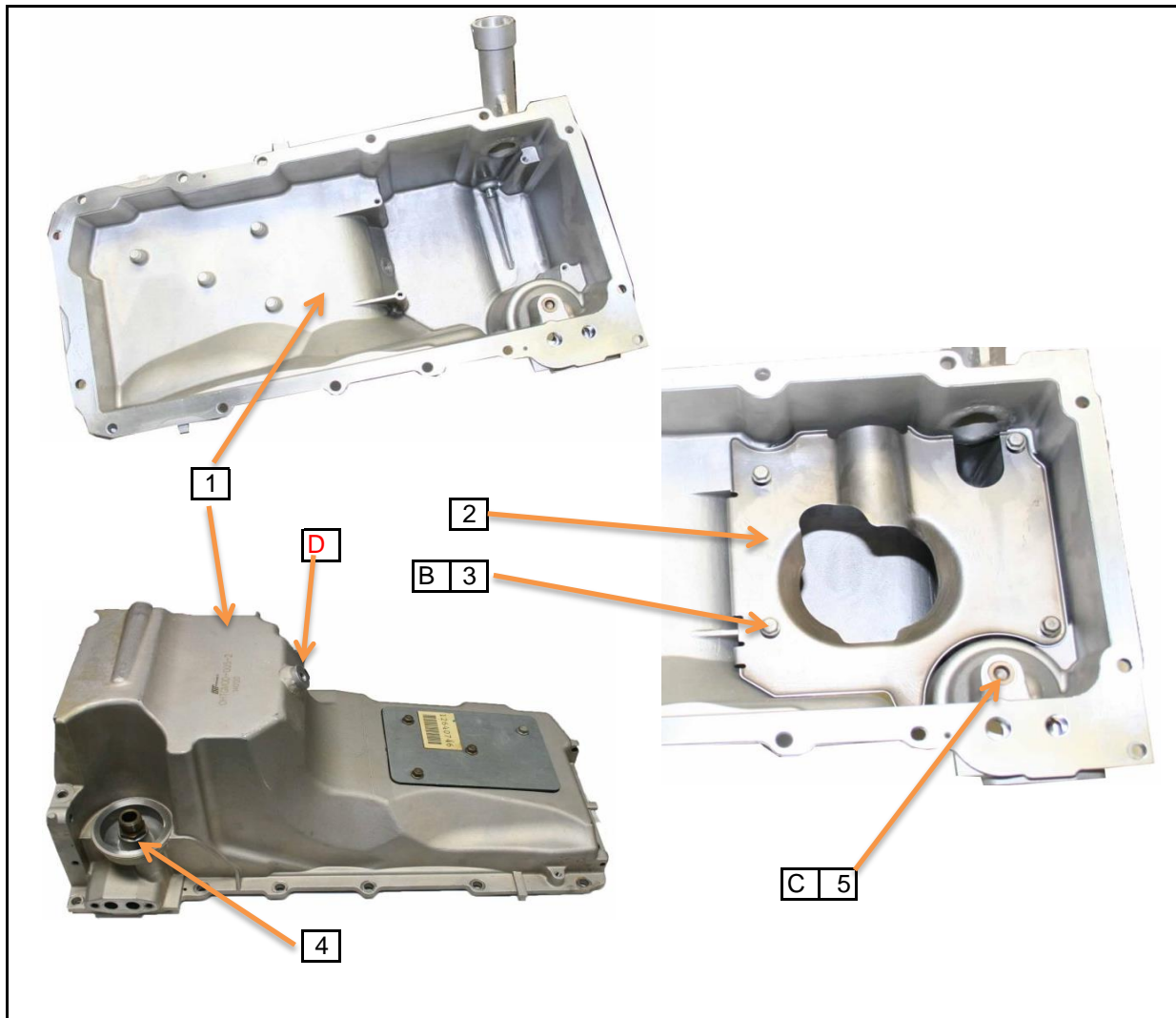

Description of Operation	
A	When cleaning the OHT Oil Pan before each test, the oil pan baffle and relief valve plug should be removed to ensure all deposits in this area are cleaned.
B	Baffle bolt torque 9Nm (80 lb in)
C	Relief Valve Plug 27 Nm (20 lb ft)
D	Install an E type 3" length Thermocouple into the oil pan so 1" protrudes from the inside surface to the tip.

Specification	
1	OHTGMOD-005-2, Oil Pan
2	12575788 Baffle, Oil Pan
3	11519133 Bolt, Oil Pan Baffle
4	12600225, Adapter Fitting, Oil Filter
5	Oil relief valve plug

REV	Date	Revision History
Short Block		GMOD

View	
OHT Oil Pan Assembly	
Section	Sheet
3	29

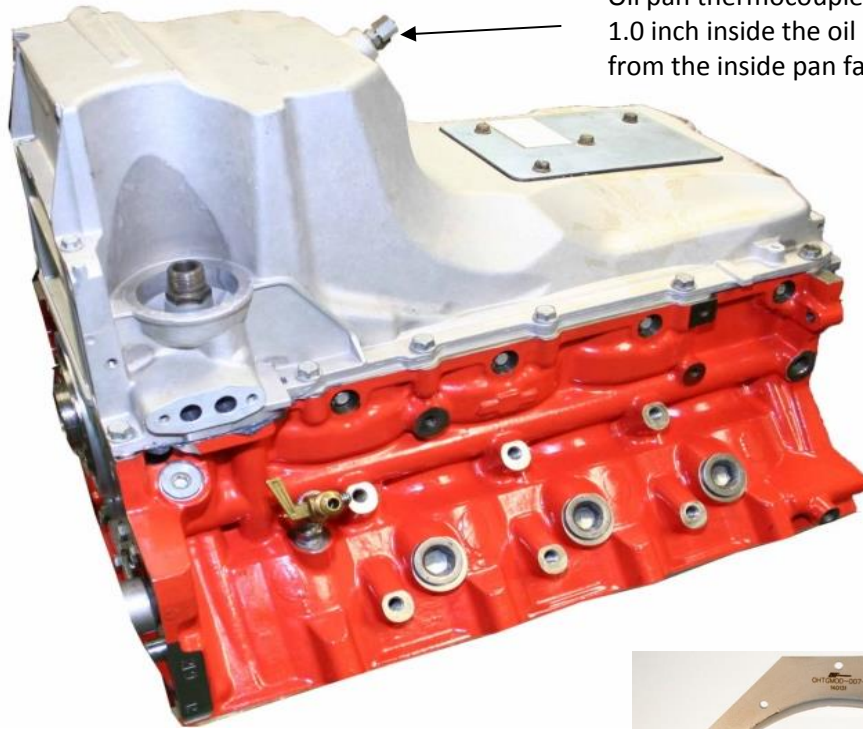

Oil pan thermocouple tip is to be set to 1.0 inch inside the oil pan. Measured from the inside pan face to the TC tip.



Description of Operation

- A Install the oil pan gasket, applying small amounts of RTV Sealant, GM RTV 12378521 at all four corners of the gasket where they contact the front and rear cover gaskets.
 - B Before installing the pan ensure the pin holding the dipstick plug is positioned so it can be removed towards the front of the engine.
 - C Align the oil pan until the rear of engine block and rear of oil pan are flush . Tighten the oil pan-to-block and oil pan-to-front cover bolts to 18 ± 1 lb.ft. Tighten the oil pan-to-rear cover bolts (long bolts) to 106 ± 2 lb. in.
- Note: Rear side of OHTGMOD-007-1 Rear Engine Mount is relief cut for clearance at the oil pan area.

Specification

- 1 OHTGMOD-005-3, Oil Pan
- 2 12612350 Gasket, Oil Pan
- 3 11515758 Bolt, Oil Pan Short (13)
- 4 12554990 Bolt, Oil Pan Long (2)
- 5 12600225, Adapter Fitting, Oil Filter
- 6 OHTGMOD-007-1, Rear Mount

REV	Date	Revision History
Short Block		GMOD

View	
Oil Pan Installation	
Section	Sheet
3	30



Description of Operation

- A Install the Canton Oil filter Adapter with new "O" rings and seals. The threaded fitting in the oil pan is torqued to 40 ft-lb. Torque the retaining bolt which threads onto the fitting to 20 lb ft.
- B Install the OHT Oil Block with a new gasket. Position the oil temperature thermocouple tip flush with the base of the oil block. Torque the retaining bolts to 80 lb in.

Specification

- 1 22-598 Oil Filter Adapter
Canton Racing Products
- 2 98-004 Seal, kit, Oil Filter Adapter
Canton Racing Products
- 3 12611384 Gasket OHT Oil Block
- 4 OHTGMOD-016-1, Oil Block

REV	Date	Revision History

View	
Oil Filter & Oil Block Installation	

Short Block

GMOD

Section
3

Sheet
31

Section 4
2/15/2016
Cylinder Head Assembly

Mark all cylinder heads with unique lab serial number.



Description of Operation

The cylinder heads are ordered as a complete assembly.

Cylinder heads are allowed to be reused for a maximum of three tests based on acceptable valve seat recession criteria guidelines.

All testing requires the use of new valves, springs, and seals for each test.

Maximum valve seat recession 0.005 in.

Maximum valve guide clearance 0.0037 in.

See Section 3 Sheets 6 & 7 for pre test measurement and rework guidelines.

Specification

1 12629058 Head Cylinder, Complete

REV	Date	Revision History

View	
Cylinder Head Complete	

Cylinder Head Assembly

GMOD

Section
4

Sheet
1

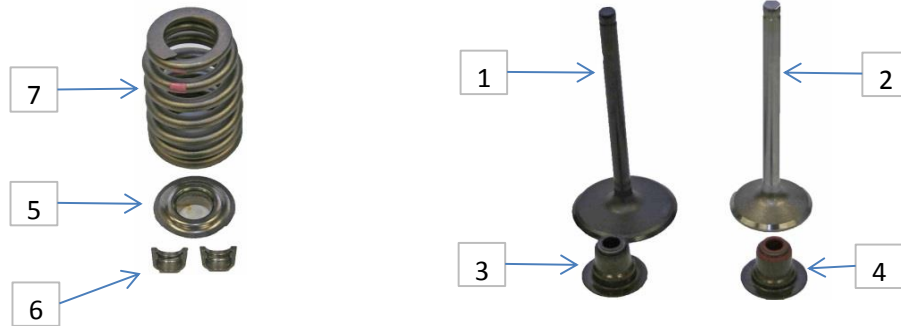

Description of Operation

A Disassemble the cylinder head and inspect all components

Clean all new cylinder head and parts with engine degreasing solvent.

Spray all components with a 50/50 solution of engine degreasing solvent and EF-411.

New cylinder heads may also be cleaned using the Ultra Sonic Cleaner.

Used cylinder heads must be cleaned using the Ultra Sonic Cleaner.

Specification

- 1 12627971 Valve, Intake
- 2 12563064 Valve, Exhaust
- 3 12482063, Seal, Intake,
- 4 12482062 Seal, Exhaust
- 5 10166344 Cap, Spring, Retainer
- 6 10166345 Keeper, Valve Stem Key
- 7 12589774 Spring, Int. & Exh.

REV	Date	Revision History

View	
Cylinder Head Components	

Cylinder Head Assembly

GMOD

Section
4

Sheet
2

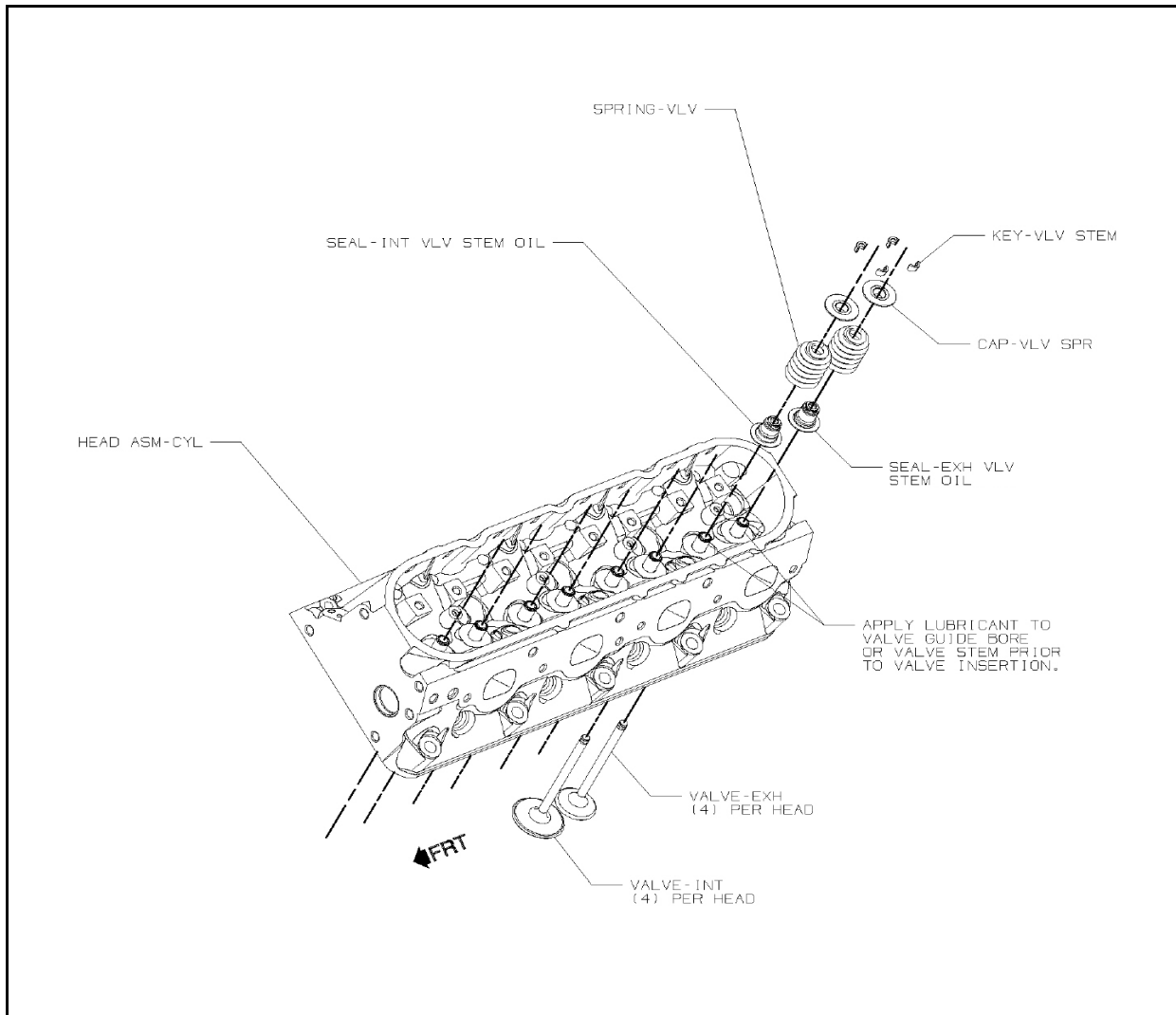

Description of Operation

Specification

REV	Date	Revision History

View
Exploded View

Cylinder Head Assembly

GMOD

Section
4

Sheet
3



Description of Operation

Measure valve guide and calculate operating clearance.

Service Specifications:

Valve stem diameter 0.313 in.

Valve stem to guide clearance, measured at top and bottom of valve guide .

Maximum 0.0037 in.

Specification

--

REV	Date	Revision History

View	
Calculating Guide to Stem Clearance	

Cylinder Head Assembly

GMOD

Section
4

Sheet
4

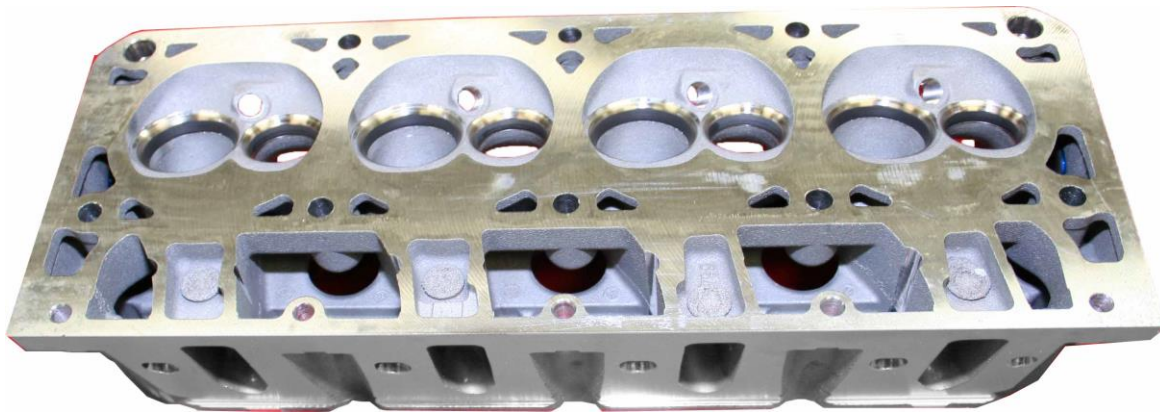

All cylinder heads must use new valves, springs, and seals for each test



Description of Operation

Apply bluing to each valve face and install. Lightly rotate the valve to transfer the bluing material between the seat and valve face. Inspect the valve seat and face for proper contact. Measure and record pre-test valve seat heights according to Section 3 Sheet 6.

Clean the bluing material from the valves and seats and assemble the cylinder heads using new valve stem seals and springs.

As a final check, labs shall use a vacuum plate over the valve ports to check for proper sealing.

Note: If desired, new cylinder heads may be lightly lapped. See Section 3 Sheet 6 & 7 for direction.

Specification

REV	Date	Revision History

Cylinder Head Assembly

GMOD

View

First Run Prep and Inspection

Section
4

Sheet
5

Procedure to Measure the Installed Valve Seat Heights

1. After lapping valves and checking contact areas, check the valve seat heights.
2. Clean cylinder head, taking care that the deck surface is free of nicks and scratches.
3. Install valve seat depth tool into valve pocket. Orientate the depth tool to the same location for each measurement in-case the ball is not centered on the valve.
4. Insure that depth micrometer is properly calibrated and zeroed on a flat surface.
5. Place the depth micrometer on cylinder head such that both ends of micrometer rest on either side of the combustion chamber.
6. Measure the depth to the ball on the end of the valve seat depth tool.
7. Record depth in thousands of an inch (0.xxx")

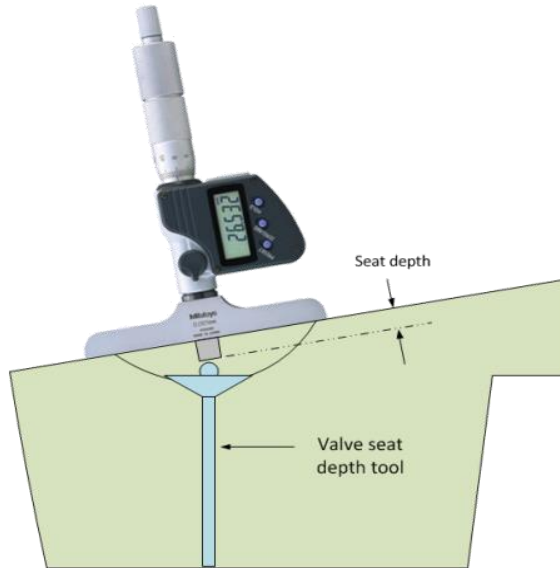

Description of Operation

Measure installed valve seat heights.

Record all seat height data on GMOD Engine Build Data Form 18.

Maximum valve seat recession for acceptable second run usage is no more than 0.005 inch Delta.

Specification

REV	Date	Revision History

View

Valve Seat Height Measurement

Valve seat height measurements are recorded for both pre-test and post-test cylinder heads. Maximum valve seat recession (change) is 0.005 inch.

Section	Sheet
4	6

Cylinder Head Assembly

GMOD

<u>Post Test Qualification and Re-Work Procedure</u> 1. Disassemble first run heads. 2. Visually inspect cylinder head and valve seats for unusual wear. 3. Measure and calculate valve guide clearance. Maximum clearance 0.0037 inch. 4. Scrape head gasket from deck surface. No sandpaper, scotchbrite pads or other abrasives which could transfer materials to the head surface may be used. 5. Check head deck for warping. Using a straight edge held diagonally across the cylinder head deck surface, measure the clearance between the straight edge and the head with a feeler gauge. Maximum 0.005" 6. Spray head with degreasing solvent and dry with compressed air. 7. Qualify re-use by measuring the delta between the pre and post-test measurements obtained from Section 3 Sheet 6 data. Maximum allowable seat recession 0.005 inch. 8. If qualified for second run, wash post-test cylinder heads using the ultra sonic cleaner to remove debris from combustion chamber and intake and exhaust ports. 9. Rinse with hot water and immediately spray with 50-50 mixture of degreasing solvent and EF411. 10. Using all new valves, lap valves using a water based valve grinding compound. Use Permatex Valve Grinding Compound, water mixed, item #80036. 11. Thoroughly clean lapping compound from valves and seats using water and a lint free rag. Be sure all lapping compound is removed. After cleaning lapping compound, spray entire head with degreasing solvent. Spray with, with 50-50 mixture of degreasing solvent and EF411 then blow dry with compressed air. 14. Apply bluing to each valve and install. Visually inspect for proper seating. The bluing ring should be a consistent width around the entire valve circumference and be positioned toward the middle of the face. If valves show proper seating appearance, clean all bluing from the valves and seats and continue assembling the heads for their second run as instructed in Section 3 Sheet 5			Description of Operation	
			Second run cylinder head cleaning and re-work guidelines.	
			Specification	
			Permatex Valve Lapping Compound Water Based #80036	
REV	Date	Revision History	View	
			Second Run Cylinder Head Re-work	
Cylinder Head Assembly		GMOD	Section	Sheet
			4	7

Section 5
2/15/2016
Long Block Assembly

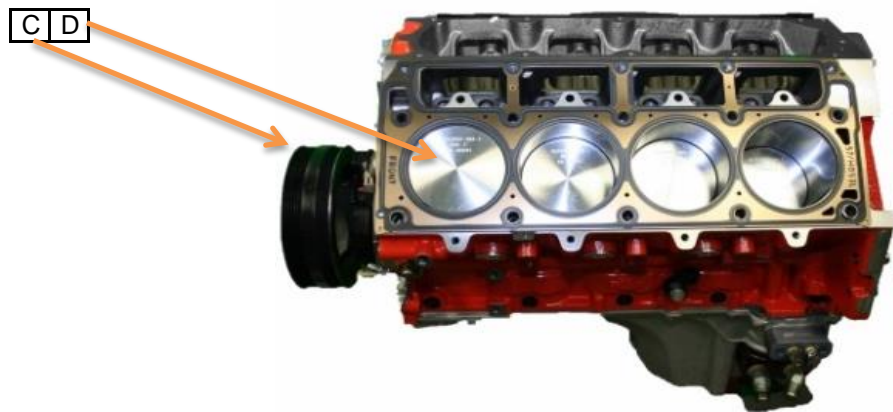
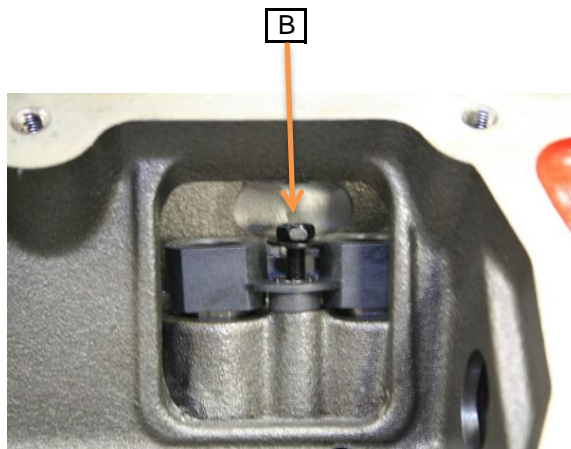
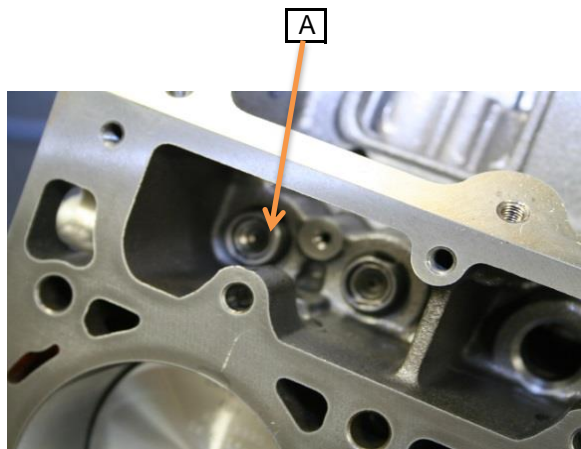

Description of Operation

- A Install new lifters each test. Lubricate each set of lifters with EF-411 making sure to lubricate the needle rollers in each lifter.
- B Install the tappet guides and bolts torque to the fasteners to; 106 ± 10 lb. in.
- C Rotate the engine watching cylinder #1 intake valve closing to confirm engine is on the compression stroke for cylinder #1. Continue rotating the engine until cylinder #1 piston is at Top Dead Center.
- D Put a tape marking on the front balancer at the 12:00 position to indicate TDC #1 cylinder.

Specification

- 1 12576400 Lifter, Camshaft Roller. (16 per engine required)
- 2 19166182 Guide, Tappet (8)
- 3 11515139 Bolt, Guide, Tappet

REV	Date	Revision History

View	
Lifter Installation	
Lifter and Retainer Guide Installation	

Long Block Assembly

GMOD

Section
5

Sheet
1

Note Red Tape Mark



Notch goes toward front of engine, right side shown

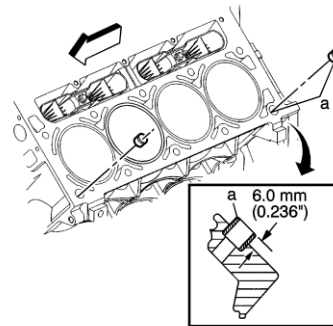

Description of Operation

- A Install the cylinder head guide dowels if not already installed.
 - B Clean the engine block deck insuring there is no debris or surface imperfections before installing the cylinder head gaskets.
 - C Install both left and right cylinder head gaskets with locating Tab toward the front of the engine.
(No sealants allowed)
- Note: Head Gaskets are left and right side orientation specific.

Specification

- 1 12570326 Dowel, Cyl. Head, Locating (4)
- 2 12589226 Gasket, Cyl. Head (2)

REV	Date	Revision History
Long Block Assembly		GMOD

View	
Head Gasket	
Section	Sheet
5	2

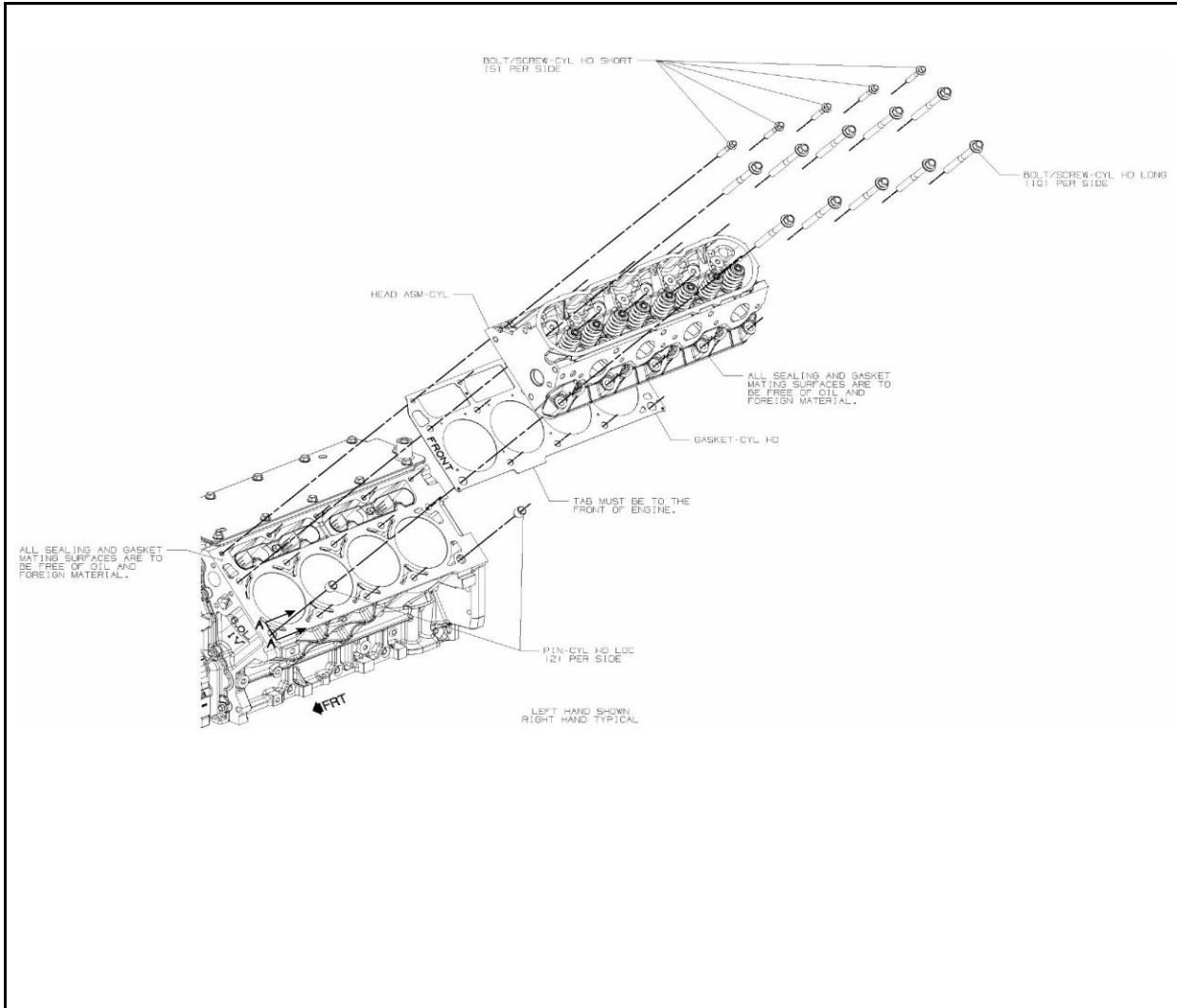

Description of Operation

Expanded view with all part numbers

- Specification**
- 19258707 Bolt Cyl. Head Long (20)
 - 12558840 Bolt Cyl. Head Short (10)
 - 12589226 Gasket, Cyl. Head (2)

REV	Date	Revision History
Long Block Assembly		GMOD

View	
Cylinder Head Expanded View	
Section	Sheet
5	3

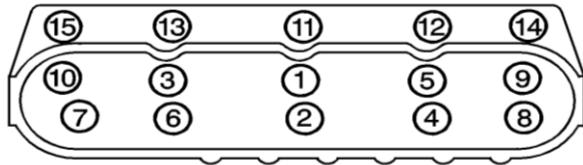
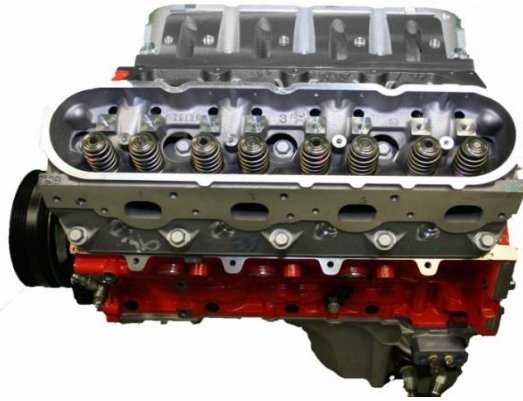

Step 1.
Tighten the M11 cylinder head bolts (1–10) a first pass in sequence to 22 ± 2 lb.ft.

Step 2.
Tighten the M11 cylinder head bolts (1–10) a second pass in sequence to $90^\circ \pm 2^\circ$

Step 3.
Tighten the M11 cylinder head bolts (1–10) a final pass in sequence to $70^\circ \pm 2^\circ$

Step 4.
Tighten the M8 cylinder head bolts (11–15) to 22 ± 2 lb.ft. Begin with the center bolt (11), alternating side-to-side, work outward tightening

Description of Operation

- A Install the cylinder heads
- B Install new cylinder head fasteners for each test. Any sealer on the new bolts is to be removed and the threads lightly lubricated with EF411 prior to use.
- C Follow the cylinder head torquing procedure as outlined in steps (1-4).

Specification

- 1 19258707, Bolt, Cyl. Head, Long (20)
 - 2 12558840, Bolt, Cyl. Head, Short (10)
- Note; All cylinder head fasteners are supplied through Chevy Performance

REV	Date	Revision History

View	
Cylinder Head Torquing	

Long Block Assembly

GMOD

Section
5

Sheet
4



A 1



B 3

B 2



Description of Operation

- A Remove all sealant from the under side of the rocker arm fasteners part number 12560961 prior to use.
- B New rocker arms, pushrods, and rocker arm fasteners are used for each test. Don't clean the rocker arms prior to use. Clean all other components with Engine Degreasing Solvent followed by 50/50 EF-411 and Engine Degreasing Solvent.
- C Properly position the rocker arm supports, pushrods, rocker arms, and loosely install all rocker arm fasteners. Follow the rocker arm tightening procedure outlined in Section 4 Sheet 6 for proper tightening to prevent valve to piston contact during tightening of the rocker arm fasteners.

Specification

- 1 12560961 Bolt, Rocker Arm
- 2 10214664 Rocker Arm, Roller Type
- 3 10238852 Pushrod
- 4 12552203 Support, Rocker Arm, Pivot

REV	Date	Revision History

View	
Overhead Valvetrain	

Long Block Assembly

GMOD

Section
5

Sheet
5

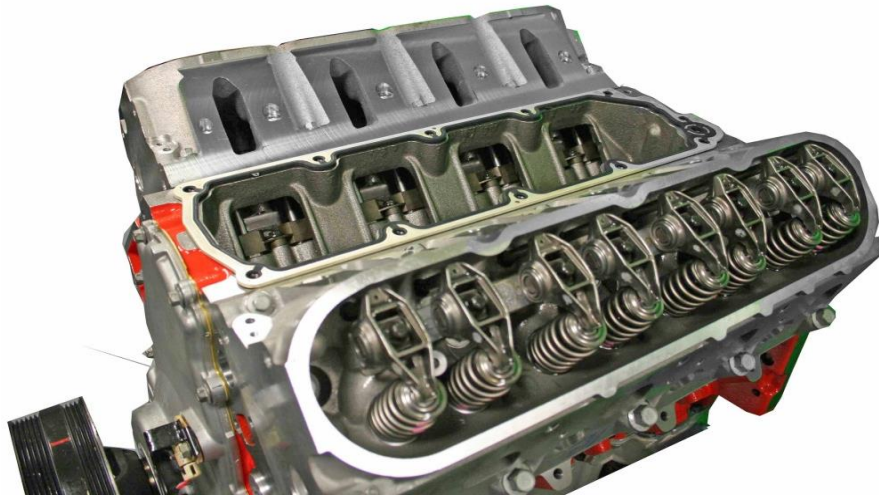

Rocker Arm Fastener Torqueing Procedure

- 1 With the engine in the number 1 firing position (as positioned in Section 5 Sheet1) tighten the following rocker arm positions;
 - Exhaust valve rocker arm fasteners cylinders 1, 2, 7, and 8
 - Intake valve rocker are fasteners cylinders 1, 3, 4, and 5
 - Allow the lifters at least 60 seconds to leak down
- 2 Rotate the engine 360° in a clockwise direction aligning the red tape mark again at 12:00 Noon
 - With the engine in the number 6 firing position tighten the following rocker arm positions;
 - Exhaust valve rocker arm fasteners cylinders 3, 4, 5, and 6
 - Intake valve rocker are fasteners cylinders 2, 6, 7, and 8

Description of Operation

Lubricate all pushrods, rocker arms, fasteners, and valve stem tips with EF-411

Loosely install all rocker arm fasteners using a speed handle.

Follow the tightening procedure applying 22 ± 2 lb. ft.

Specification

REV	Date	Revision History

View

Rocker Arm Tightening Procedure

Section

5

Sheet

6

Long Block Assembly

GMOD



Description of Operation

A Install Valley Cover Gasket , Valley Cover, and Fasteners.

Torque fasteners from inside out to 18 ± 2 lb.ft.

Specification

- 1 12610141 Gasket, Valley Cover
- 2 12598832 Cover, Valley
- 3 11518075 Bolt, Valley Cover

REV	Date	Revision History

View	
Valley Cover Installation	

Long Block Assembly

GMOD

Section
5

Sheet
7

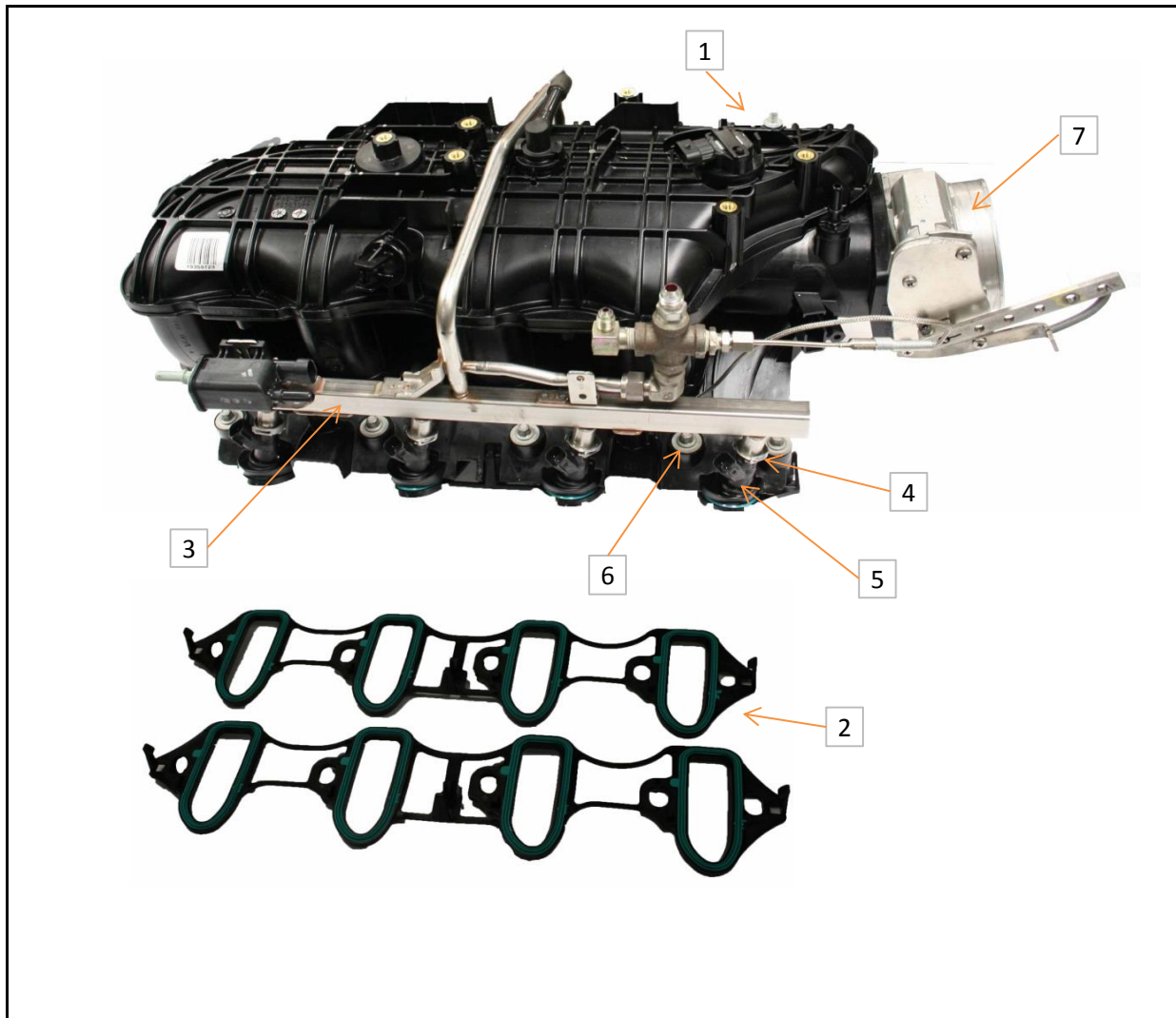

Description of Operation

Intake plenum assembly

Specification

1	12644373 Assembly Intake Manifold
2	12600255 Gasket, Intake (2)
3	12621668 or 12660709 Rail, Fuel
4	12570620 Retainer Fuel Injector
5	12613411 Injector, Fuel
6	12575384 Fastener, Intake Manifold
7	12629992 Body Throttle, Modified

REV	Date	Revision History

View

Intake Plenum Assembly

Long Block Assembly

GMOD

Section
5

Sheet
8

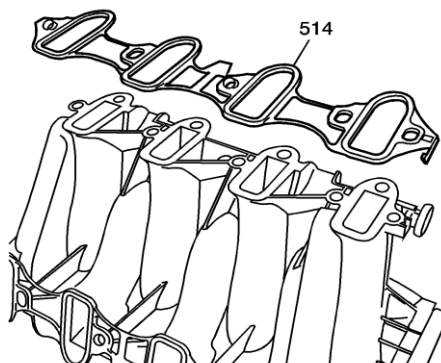
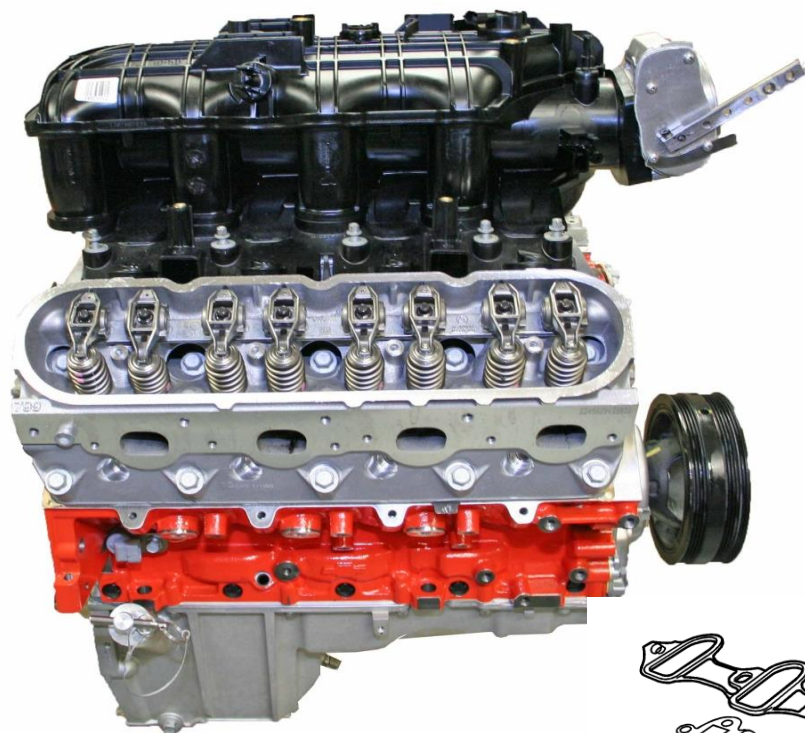

Description of Operation

Clean and inspect the induction system for any loose materials inside the runners from storage.

Install new gaskets on the intake plenum.

Install the assembly onto the assembled short block.

Tighten the intake manifold fasteners using a speed handle from the inside out to snug.

Specification

REV	Date	Revision History

View

Intake Manifold Installation

--	--

Long Block Assembly

GMOD

Section
5

Sheet
9

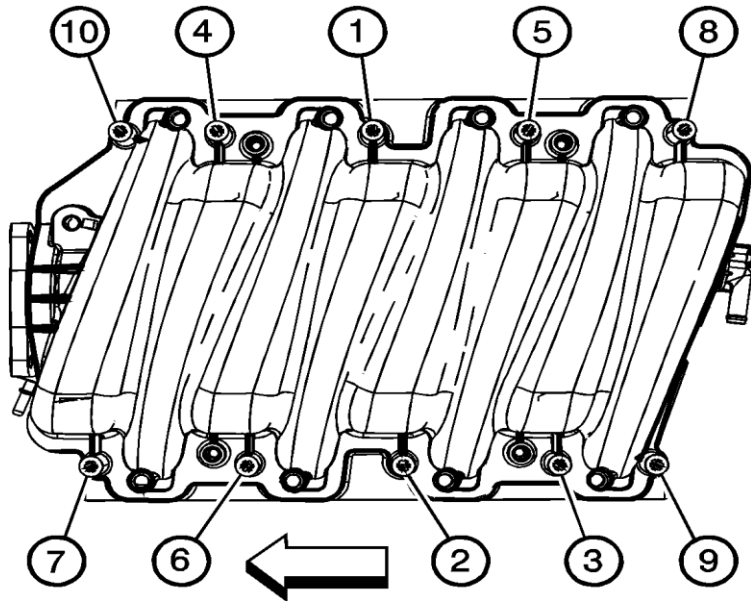

Description of Operation

Tighten the intake manifold bolts (1-10) a first pass in sequence to 44 ± 2 lb. in.

Tighten the intake manifold bolts (1-10) a final pass in sequence to 89 ± 2 lb.in.

Specification

1 12575384 Bolt, Intake Manifold

REV	Date	Revision History

Long Block Assembly

GMOD

View

Intake Manifold Tightening

--	--

Section
5

Sheet
10

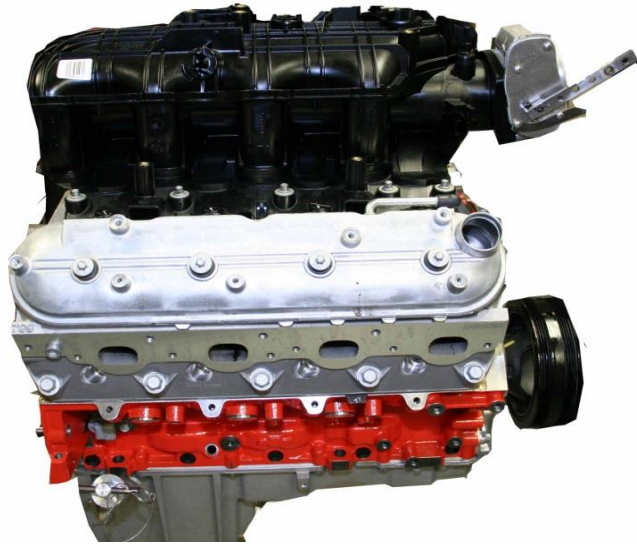

Description of Operation

The GMOD Test uses two right side rocker covers for test operations.

Care must be taken to ensure the rocker covers have been properly cleaned using the sonic cleaner to remove any deposits in the baffle area.

Install new rocker cover gaskets with new cover bolts and grommets for each test.

Tighten rocker cover retainer bolts to 106 ± 2 lb. in.

Specification

- 1 12637683 Gasket, Rocker Cover
- 2 12582224 Cover, Rocker
- 3 12577215 Bolt, Cover, Rocker w/Grommet

REV	Date	Revision History

View

Rocker Cover Installation

--	--

Long Block Assembly

GMOD

Section
5

Sheet
11

<p style="text-align: center;">Fuel Injector Flow Test Procedure</p> <p style="text-align: center;">Flow test the fuel injectors before each test:</p> <ol style="list-style-type: none"> 1. Use aliphatic naphtha (Warning —Flammable Health hazard.) as the calibration fluid. 2. Apply 276 kPa to the fuel rail. 3. Apply 13 V to the injector solenoid continuously. 4. Allow the injector to spray into a graduated cylinder capable of holding at least 250 mL. 5. Volume-check all injectors for 30 s and note the volume produced by each injector. 6. Observe the spray pattern that each injector produces; if the injector has a straight stream or dribbles, it must be discarded. 7. The eight injectors that are to be installed on an engine fuel rail shall produce volumes that are within 5 mL of each other. 8. Remove the solvent that is remaining in the injector from the flow check using compressed air. 			Description of Operation		
			<p>Install fuel rail with injectors to the intake plenum.</p> <p>Flow test the fuel injectors before each test according to the procedure on this page.</p> <p>Use a set of flow matched injectors with new "O" Rings for each test.</p> <p>Tighten the fuel rail retaining fasteners to 89 ± 10 lb.in.</p>		
			Specification		
			1	12621668 or 12660709 Rail, Fuel	
			2	12570620 Retainer Fuel Injector	
			3	12613411 Injector, Fuel	
			4	12580910 Bolt Fuel Rail	
REV	Date	Revision History	View		
			Fuel Rail Assembly Installation		
			Reference Section 4 Sheet 8 for Induction System Illustration		
Long Block Assembly		GMOD		Section	Sheet
				5	12

Description of Operation

Install the coil pack assembly to each side rocker cover.

Insure all connections are clean and clip locks are in place.

Replace the spark plug wires as needed.

Torque the coil pack assembly to the rocker cover to 89 ± 10 lb. in.

Specification

- 1 12580353 Bracket, Coil Pack
- 2 12611424 Coil
- 3 11516424 Bolt, Coil to Bracket
- 4 12579355 Wire Pack, Coil Assembly
- 5 12554211 Bolt, coil Pack to Cover (5)
- 6 9059C Wire Spark Plug (Accel)

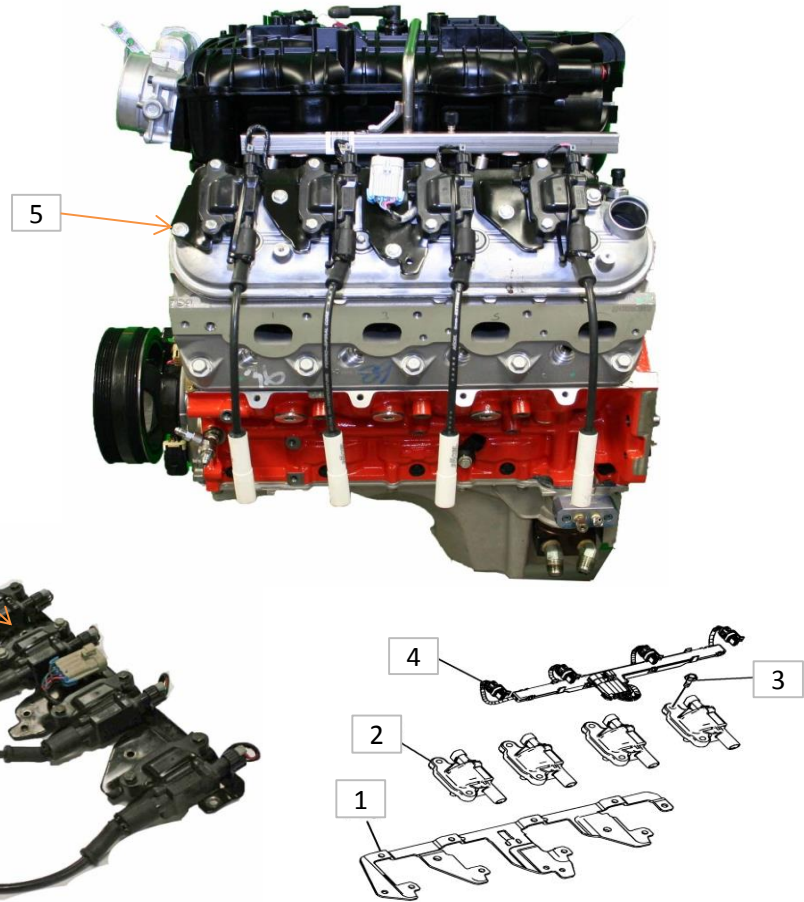

REV	Date	Revision History

View	
Coil Pack	

Long Block Assembly

GMOD

Section
5

Sheet
13

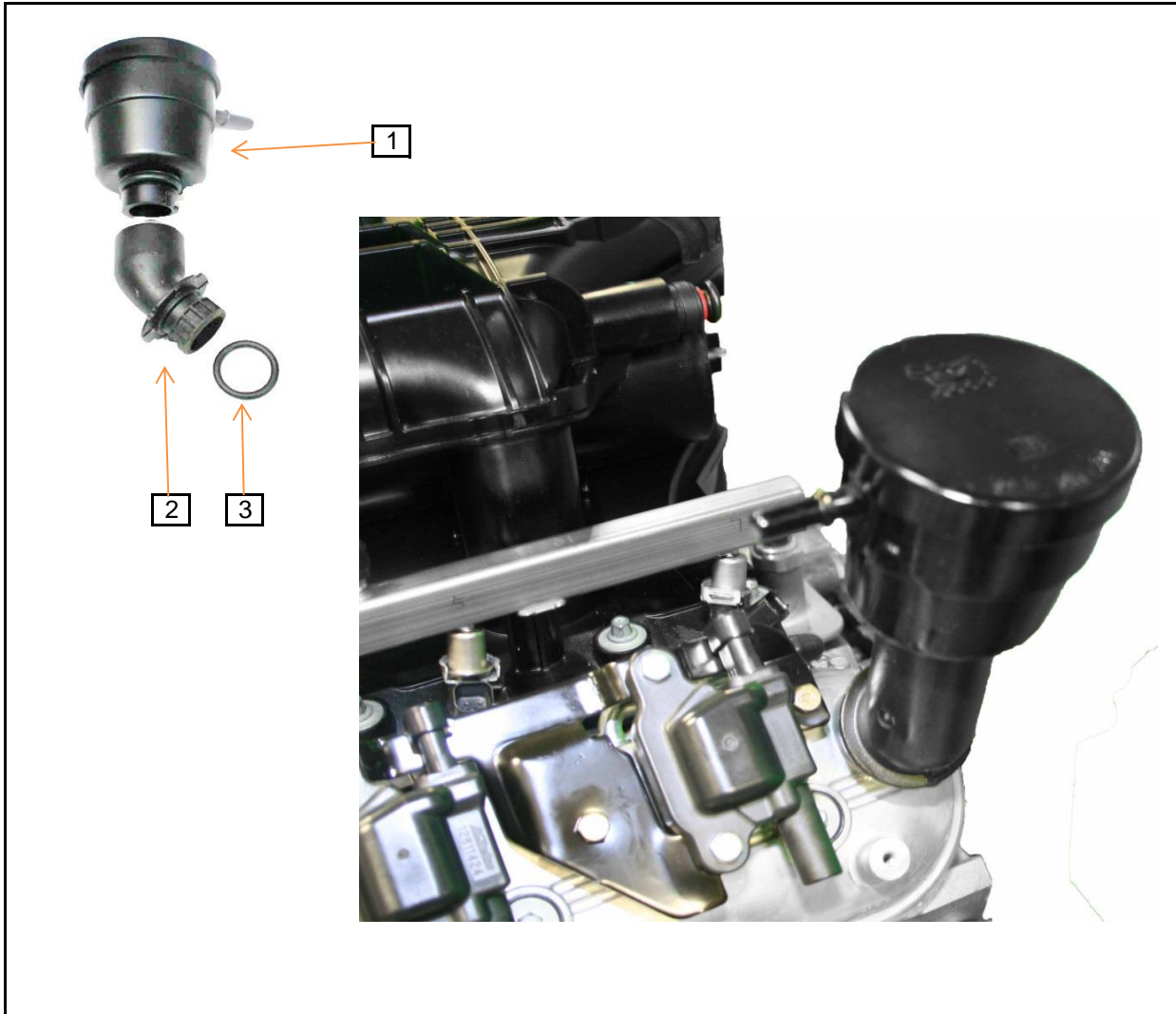

Description of Operation

Disassemble and clean the Camaro Oil Breather / Separator and install new "O" Ring seals for each test.

Specification

- 1 12653073 Oil Separator, Camaro
- 2 12584043 Extension, Oil Fill
- 3 12593348 Seal, "O" ring (2 each side)
- 12656319 O-ring large, Oil Separator

REV	Date	Revision History
Long Block Assembly		GMOD

View	
Camaro Oil Breather	
Section	Sheet
5	14



Modify coolant air bleed cross over tube by cutting air bleed tube flush.
 Drill and tap for 1/8 NPT.
 Use Aeroquip #4 braided line to connect air bleeds at front and rear to coolant system return.
 Use Coolant Pipe Assembly 12605716 on both front and rear of the engine.
 Slight bending for clearance at the rear of the engine is required.

Description of Operation

Modify coolant air bleed cross over pipe 12605716 by cutting the air bleed tube flush then drill and tap for 1/8 NPT. Use Aeroquip #4 fittings to connect coolant air bleeds to the return side of the coolant system.

Use a modified air bleed cross over pipe assembly 12605716 on both the front and rear of the GMOD Engine.

Use new "O"rings on the pipe assemblies each test. Torque the cross over tube fasteners to 106 ± 10 lb. in.

Torque the coolant inlet manifold fasteners a first pass to 11 ± 2 lb.ft. Tighten the coolant manifold fasteners a final pass to 22 ± 2 lb ft.

Specification

- 1 12605716 Pipe Assembly
- 2 11588715 Bolt Air Bleed Tube (4)
- 3 12602541 Seal "O"ring (4)

REV	Date	Revision History

View	
Coolant Manifold & Air Bleed	
Coolant Manifold & Air Bleed Modification	

Long Block Assembly

GMOD

Section
5

Sheet
15



Description of Operation

Install the OHT Coolant Manifold Assembly.

Torque the coolant manifold fasteners a first pass to 11 ± 2 lb.ft.

Tighten the coolant manifold fasteners a final pass to 22 ± 2 lb ft.

Specification

- 1 12630223 Gasket OHT Coolant Manifold
- 2 OHTGMOD-008-1 Coolant Manifold

REV	Date	Revision History

View	
Coolant Manifold & Air Bleed	

Long Block Assembly

GMOD

Section
5

Sheet
16

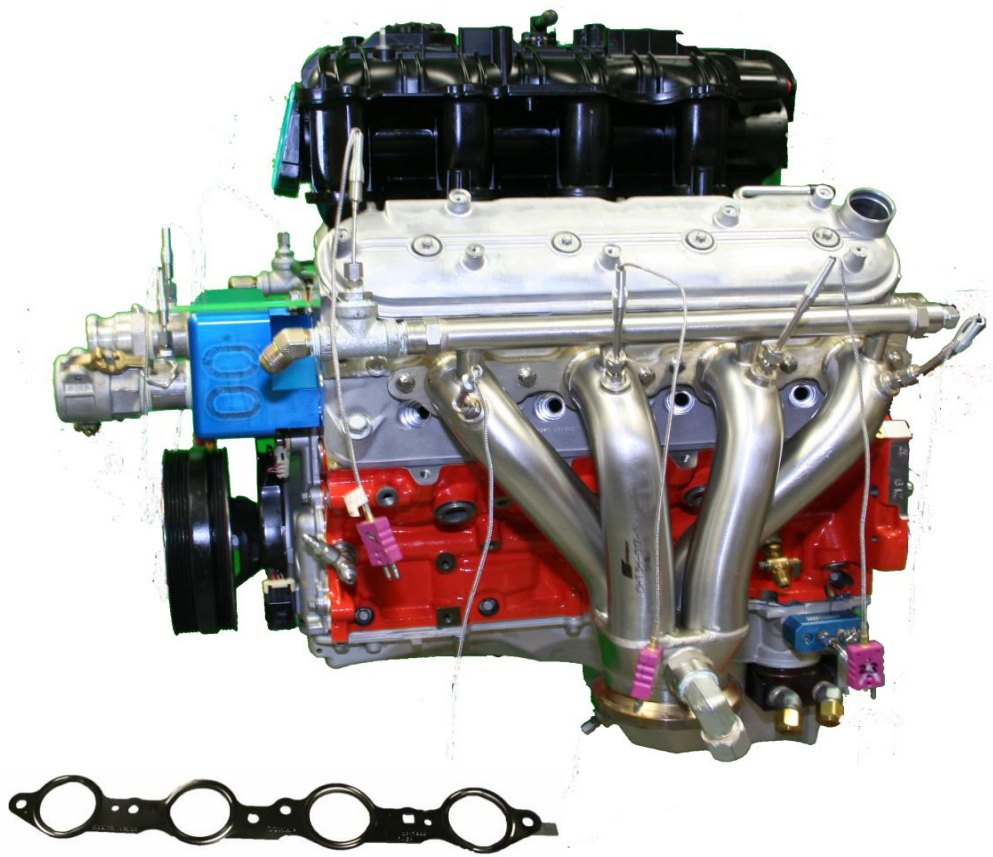

Description of Operation

If the engine is ready to go into the test cell, install the water cooled exhaust manifolds using new gaskets and tighten the manifolds working from the center out.

Tighten the exhaust manifold fasteners a first pass to 11 ± 2 lb.ft. with a second pass to, 15 ± 2 lb. ft.

Specification

- 1 OHTGMOD-017-1 Exh. Manifold Water Cooled, w/Takedown Tube
- 2 12617944 Gasket, Exh. Manifold

REV	Date	Revision History

View	
Water Cooled Exhaust Manifold	

Long Block Assembly

GMOD

Section
5

Sheet
17

Section 6

Final Dress and Instrumentation

2/15/2016

			Description of Operation	
			<p>A Install the flywheel to the crankshaft.</p> <p>B Install flywheel bolts with GM RTV Sealer on the threads. Sealer required to prevent oil leak.</p> <p>C Tighten the bolts in the sequence indicated</p> <p>D</p> <ol style="list-style-type: none"> 1. First pass to 20 Nm (15 lb ft) 2. Second pass to 50 Nm (37 lb ft) 3. Final pass to 100 Nm (74 lb ft) 	
			Specification	
			<p>1 12571611, Flywheel</p> <p>2 OHTGMOD-203-1, Bolt, Flywheel</p> <p>GM RTV 12378521 or 88864346</p>	
Revision History			View	
REV	Date		Flywheel Installation	
Final Dress		GMOD		Section
				6
				Sheet
				1

GMOD External Oil System Setup and Flow Direction Camaro Oil Cooler Heat Exchanger

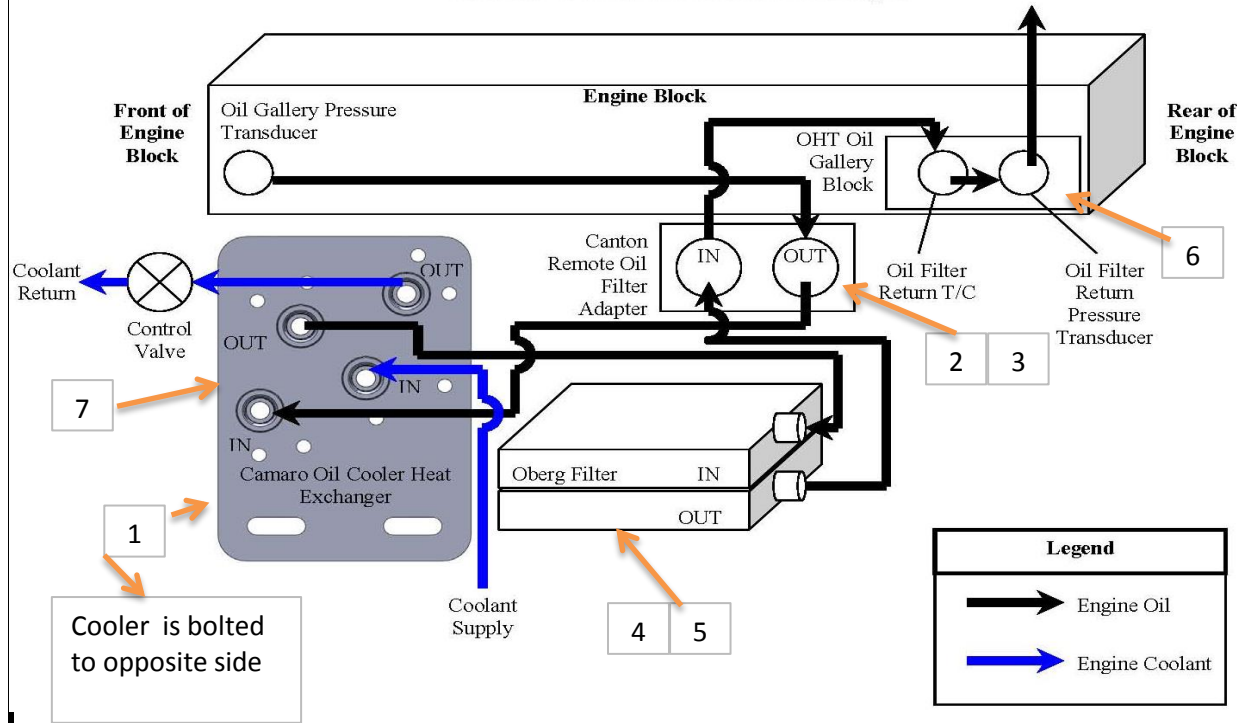

1
Cooler is bolted to opposite side

The Camaro Oil Cooler Plate is manufactured in-house, see Appendix B2 in the TSCM.

The external oil cooler circuit uses pressurized engine coolant taken from the main coolant system before the flow meter, returning down stream of the engine coolant outlet.
No additional cooling circuits are allowed.

Description of Operation

The GMOD External Oil Cooler Circuit takes oil out of the Canton remote oil filter adapter, directing it through the Camaro Oil Cooler, the Oberg external oil filter which uses a 60 μ filter screen, and back into the Canton remote oil filter adapter.

The engine oil then enters the block through the oil pan gallery and the OHT Oil Pressure Block.

Coolant for the Camaro Oil Cooler is Engine Coolant taken from the cooling system such that it does not effect the main engine coolant flow.

All fittings and line maximum lengths are specified in the TSM. No 90 degree oil line fittings are to be used.

Specification

- 1 12607900 Camaro Oil Cooler
- 2 CTR-22-598 Canton Remote Oil Adapter
- 3 CRT-98-004 Canton O-ring Kit
- 4 OHT6A-012-2 Oberg Oil Filter
- 5 OHT6A-013-3 60 Micron Filter Screen
- 6 OHTGMOD-016-1 Block, Pressure Oil
- 7 Camaro Oil Cooler Plate

REV	Date	Revision History

View	
External Oil Cooler Circuit	

Final Dress	GMOD
-------------	------

Section	Sheet
6	2

Section 7

OHT Hardware

2/15/2016

Description of Operation

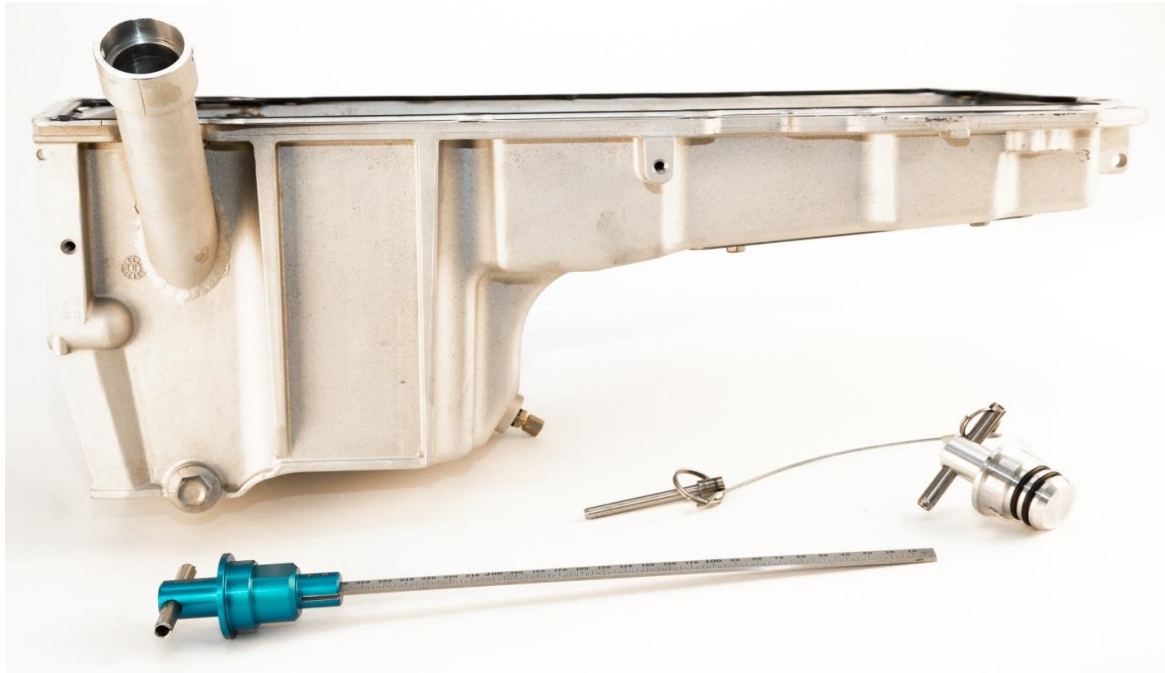

Specification

- 1 OHTGMOD-005-1 Pan, Oil
- 2 OHTGMOD-005-18 Plug, Dipstick
- 3 OHTGMOD-005-25 Dipstick, Oil

REV	Date	Revision History

View	
Oil Pan with Dipstick & Plug	

OHT

GMOD

Section
7

Sheet
1



Description of Operation

Specification

1 OHTGMOD-008-1 Manifold, Coolant

REV	Date	Revision History

View

Coolant Manifold

OHT

GMOD

Section

7

Sheet

2

Description of Operation

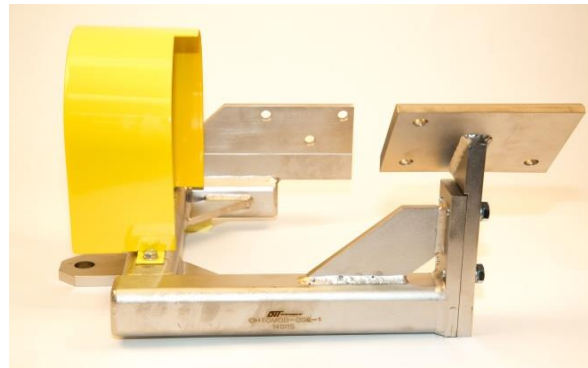

Specification

1 OHTGMOD-006-1

REV	Date	Revision History

View	
Front Engine Mount Assembly	

OHT

GMOD

Section
7

Sheet
3

Description of Operation



Specification

1 OHTGMOD-007-1

REV	Date	Revision History

View

Rear Engine Mount

OHT

GMOD

Section

7

Sheet

4



Description of Operation

Specification
 1 OHTGMOD-004-1 Tool, Cam Bushing

REV	Date	Revision History

View
Cam Bushing Installation Tooling

OHT

GMOD

Section
 7

Sheet
 5



Description of Operation

Specification

1 OHTGMOD-016-1 Block, Pressure, Oil

REV	Date	Revision History

View

Oil Pressure Block

OHT

GMOD

Section
7

Sheet
6



Description of Operation

Specification

1 OHTGMOD-017-1 Manifold, Exhaust Water Cooled with Take Down Tube

REV	Date	Revision History

View

Water Cooled Exhaust Manifold

OHT

GMOD

Section
7

Sheet
7



Description of Operation

Specification

- 1 OHTGMOD-015-1 Cover, Rear
Replaces 19166179 which leaks oil

REV	Date	Revision History

View
Rear Cover

OHT

GMOD

Section
7

Sheet
8

Section 8

Ultrasonic Maintenance and Parts Cleaning Procedure

2-15-2016

Maintenance Procedure:

- 1) Turn on the pump in the ultrasonic machine to skim the oil off of the top. Use a hose with tap water to aid in spraying the oil out of the side skimmer.



- 2) Ensure that the ultrasonic machine is powered OFF. The transducers can fail if the ultrasonic machine is left on.



- 3) Drain ultrasonic machine main unit and oil separator bin.



- 4) Spray out residue from inside of the main unit of the ultrasonic machine towards the drain.



- 5) Spray out the oil separator bin on the left of the ultrasonic cleaner and drain.

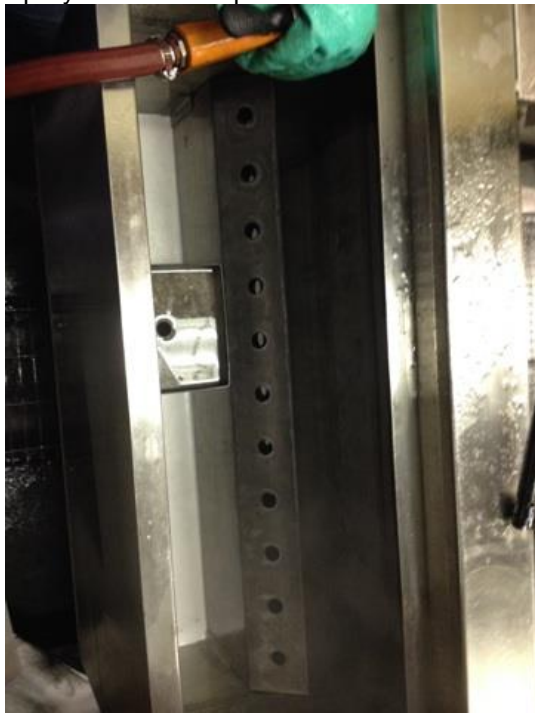

- 6) Fill the oil separator bin with water and turn on the pump to purge the lines of all contaminants. This will pump into the main unit of the ultrasonic cleaner and will need to be rinsed down the drain once the pump is turned off.
- 7) Close the drain valves and fill the main unit of ultrasonic machine $\frac{1}{4}$ of the way with water from the tap, if the water is not clear drain and spray out the ultrasonic machine to rid it of all contaminants and refill with tap water.
- 8) Fill the ultrasonic machine with tap water up above the $\frac{3}{4}$ mark of the ultrasonic machine main unit and skimmer unit.
- 9) Power the ultrasonic machine back on and set the heat to a minimum of 140°F. This step will take about 5 – 6 hours.



- 10) Add solution once ultrasonic machine reaches a minimum of 140°F. DO NOT add the degreasers until the ultrasonic machine has reached a temperature of 140°F.
 - a. 5 ½ gallons of ultrasonic solution 7
 - b. ½ gallon of ultrasonic solution B
 - c. Change the soap and water solution at least after every 25 h of use.
*Note: The solution shown above is based upon the MOT-500NS model (158 gallon capacity), please adjust the solution rate to 0.035 gallons (4.48 oz) of ultrasonic solution 7 to one gallon of water and 0.003 gallons (0.38 oz) of ultrasonic B to one gallon of water for larger or smaller units.
- 11) De-aerate the ultrasonic machine solution for a minimum of 2 hours by powering the Ultrasonic transducers on at a minimum temperature of 140°F.
- 12) As water evaporates from the ultrasonic bath between soap change intervals, return the bath to the fill line prior to each use with tap water.

The engine block Post Hone Cleaning Procedure is in Section 3, Sheet 1.

Parts Cleaning Procedure:

- 1) Ensure Ultrasonic Machine is on at a minimum temperature of 150 + or - 10°F.
- 2) Cycle the pump in the ultrasonic machine to skim the oil off of the top prior to washing every engine block for a minimum of 15 minutes.
- 3) Place GMOD engine hardware on Ultrasonic Machine lift table.
- 4) Lower Ultrasonic Machine lift table, close the hydraulic lid, and turn on ultrasonics and oscillation movement to the lift table.
- 5) Leave GMOD engine hardware in the Ultrasonic Machine for 60 minutes + or – 15 minutes.
- 6) Remove the GMOD engine hardware and spray with hot water for one minute. DO NOT spray the hardware over the ultrasonic cleaner bath.
- 7) Immediately after spray the GMOD Hardware with 50/50 EF411 and Solvent to remove the water and prevent rust and oxidation flash over.

Section 9

GMOD Special Test Equipment

2-15-2016

- **Sunnen Equipment**
 - Model SV-10 Honing Machine
 - Honing stones: DHH7GMH55, DHH7RMH907, DHHB7534
 - SHO965 honing fluid
 - Honing Filter PF105 (5 micron)
 - Matts CV-1100
- **Surface Finish Measurement Equipment**
 - Mitutoyo Surftest SJ410
 - Deep Groove Stylus (5 μ m tip): 12AAB409
 - Skid Nose Piece: 12AAC755
 - 50 mm Extension: 12AAG202
 - Surface Analyzer support plate (See GMOD Test Stand Manual, Appendix F)
- **Ultra Sonic Engine Cleaner**
 - Tierra Tech MOT-500NS or larger size
- **Build Measurement Equipment**
 - Starrett No270 Tapered Gage
 - Dial Bore Gage for measuring the bores
 - Master Ring gage 99.000 mm (3.900")
 - Bore Measurement Ladder (See GMOD Test Stand Manual, Appendix H)
- **Additional Equipment**
 - Suitable certified scale for measuring the initial oil fill

Section 10

Parts List

2/15/2016

GMOD Parts from Chevy Performance Warehouse

Description	Part Number	Quantity per engine	Part Replacement
Block, GMOD with main bearing caps and AN	88958771	1	6 tests
Crankshaft, w/reluctor	12588612	1	6 tests
Pin, piston	12570512	8	each test
Rods, conn includes bolt and cap	12649190	8	each test
Camshaft	12625437	1	6 tests
Head-cyl w/valves installed	12629058	2	3 tests
Seal Kit, Intake valve, quantity of 8 per bag	12482063	1	each test
Seal Kit, Exhaust valve, quantity of 8 per bag	12482062	1	each test
Bolt, head long	19258707	20	each test
Bolt, head short	12558840	10	each test
Camaro Oil Cooler	12607900	1	as needed
O ring seal for cooler	12613165	4	each test
Dyno Wiring Harness	GMOD Harness	1	as needed
Engine Controller, GMOD 1013	GMOD 1013	1	as needed
Throttle Pedal Simulator	xx031519aa	1	as needed
Manifold, Intake ASM	12644373	1	as needed
O-ring kit, Coolant AN Core plugs	GMW395	1	each test
O-ring, Coolanet Large Core Plugs	MS92794	8	Each test
O-ring, Camaro oil separator	12656319	2	each test

GMOD Parts Purchased From GM Dealership

From Dealers	Part Number	Quantity per engine	Part Replacement
Plug, block oil gallery	12573460	1	each test
Plug, Main Oil Gallery	14090911	1	as needed
Head Locator Dowels	12570326	4	as needed
Pin, Transmission Location	1453658	2	as needed
Core plug hole	9427693	1	each test
Bolt, Lifter Guide	11514139	8	6 runs only
Bolt, Cam Thrust Plate	11561455	6	6 runs only

Gasket, Oil Pan	12612350	1	each test
Gasket, Oil Pan Cover	12611384	1	each test
Oil Pickup tube, includes seal	12608579	1	seal each test
Seal, Oil Pump Pickup Tube	12584922	1	each test
Bolt, pickup tube	11519133	1	6 runs only
Deflector, CR/SHF oil	12611129	1	as needed
Nut, deflector and oil pickup tube	11609746	9	6 runs only
Bolt, Oil Pan	11515758	1	6 runs only
Bolt, Oil Pan long	12554990	2	6 runs only
Key, cr/shf balr	12561513	1	6 runs only
Sprocket-CR/SHF	12556582	1	6 runs only
	12634105 or	1	
Harmonic Balancer	19300488		as needed
Bolt, Harmonic Balancer	12557840	1	each test
Bolts, flywheel	11569956	6	each test
Seal, Crankshaft rear	89060436	1	each test
Rear Cover	49166179	1	Use OHT part
Bolt, rear housing	11588723	12	6 runs only
Dipstick tube	12625031	1	as needed
Seal, dipstick tube	24504031	1	each test
Cam thrust retainer plate	19244460	1	6 runs only
Sprocket, Cam	12591689	1	each test
Bolt-camshaft spkt	11561283	3	each test
Throt Body	12629992	2	no
Pump ASM-Oil	12586665	1	6 runs only
Bolt-O/PMP	11515758	4	6 runs only
Tensioner, Timing Chain W/Bolts	12626407	1	each test
Chain ASM-TMG	12646386	1	each test

GMOD Parts Purchased From GM Dealership

Cover asm-eng frt w/ bolts, cam sensor, se	12633906	1	as needed
Breakdown of the front cover ASM			
Front Cover	12600326	1	as needed
Camshaft Position Sensor	12591720	1	as needed
Sensor bolt	11588712	1	as needed
Sensor wire assembly	12627501	1	as needed
Bolt, Front cover	11515758	8	6 runs only
Gasket, eng frt Cover	12633904	1	each test
Seal, eng frt Cover	12585673	1	each test
Flywheel	12571611	1	as needed
Bolts, flywheel	11569956	6	
pushrod	10238852	16	each test
Rocker	10214664	16	each test
Rocker arm bolts	12560961	16	each test
Support, valve rocker arm pivot	12552203	2	as needed
Lifter	12576400	16	each test
Guide, tappet	19166182	8	6 runs only
Gasket, Rocker Cover (LH & RH)	12637683	2	each test
Rocker cover, RH	12582224	2	as needed
Oil Fill Tube	12584043	2	as needed
Seal, Oil fill tube	12593348	2	each test
Bolt, Rocker Cover	12577215	8	6 runs only
Head Gaskets	12589226	3	each test
Gasket, Intake	89060413	2	each test
Valve, intake	12627971	8	each test
Valve, exhaust	12563064	8	each test
Spring, Valve	12589774	16	each test
Cap, Vlv Spr	10166344	16	each test
Key, VLV SPR	10166345	2	each test
Plug, cyl head	11610259	1	as needed
Pipe ASM -eng cool air bleed	12605716	2	as needed
Cover, engine coolant air bleed	12602540	2	as needed
Bolt-Engine Cool Air Bleed Pipe and cover	11588715	4	no
Seal, Coolant cross-over tube and cover	12602541	4	each test
Gasket, Water Pump	12630223	2	each test
Gasket, Valley	12610141	1	each test
Spark Plugs AC Delco, 41-110	12621258	8	each test
Coil, Ignition	12611424	8	as needed

GMOD Parts Purchased From GM Dealership

coil jumper wires	12579355	2	as needed
Brackets-coil	12580353	2	as needed
Bolts-coil	11516424	8	as needed
Stud, Ign coil brkt to cvr	12554211	10	as needed
Plug wires, ACCEL 9059C		8	as needed

Sensor, Oil Pressure	12621234	1	as needed
Sensor, coolant	12608814	1	as needed
Sensor ASM-Crankshaft posn	12585546	1	as needed
Bolt-CR/SHF posn sensor	11515756	1	as needed
SENSOR ASM-KNOCK	12623730	1	as needed
Sensor, O2	12581966	2	as needed
Camaro oil separators	12653073	2	as needed
Gasket, exh manifold	12617944	2	each test
O ring seal for cooler	12613165	4	each test

Cover ASM, valley (W/ Bolts / gaskets)	12598832	1	as needed
Bolt, Valley	11518075	11	as needed
Air filter	92196275	1	as needed
Air Box	92230374	1	as needed
Sensor, MAF	15865791	1	as needed
Duct	92196314	1	as needed
Seal Kit, Injector	19169305	8	each test
Retainer, Injector	12570620	8	each test

<u>Components of the Intake Manifold Assm</u>			
Manifold, Intake	12638038	1	as needed
Gasket, Int Manif	12600255	1	each test
Screw, fuel rail mounting	12580910	4	as needed
Throt Body	12629992	1	as needed
Stud, ACV mounting	11588398	1	as needed
Nut, ACV mounting	12580908	1	as needed
Screw, ACV	12580909	1	as needed
Seal - ACV	12589235	1	as needed
Sensor, MAP	12644228	1	as needed
Fastener, manifold	12575384	10	as needed
Purge Solenoid	12639220	1	as needed
Harness _ EVAP Emis CNSTR	12574897	1	as needed
Injector	12613411	8	each test
Valve asm fuel pressure serv vlv	12568158	1	as needed

GMOD Parts Purchased From GM Dealership

Cap, Fuel pressure serv vlv	25532662	1	as needed
Ground bracket	12593800	1	as needed
Fuel rail w/o injectors	12621668	2	as needed
Fuel rail w/o injectors, alternative	12660709	1	as needed
MAP sensor retainer	12615934	1	as needed

GMOD Parts Purchased from OHT

Description	Part Number	Quantity per engine	Part Replacement
BEARING, ENGINE SET (MAIN, CONN ROD TOOL, RING INSTALLATION	OHTGMOD-001-1	1	each test
TOOL, CAM BEARING INSTALLATION	OHTGMOD-003-1		
PAN, OIL, MODIFIED	OHTGMOD-004-1		
Heat sheild. Oil pan left	OHTGMOD-005-2	1	as needed
Heat sheild. Oil pan right	GMOD-005-32	1	as needed
MANIFOLD, COOLANT IN / OUT	GMOD-005-33	1	as needed
BLOCK, PRESSURE, OIL, REAR	OHTGMOD-008-1	1	as needed
MANIFOLD, EXHAUST, WATER COOLED, IN	OHTGMOD-016-1	1	as needed
	OHTGMOD-017-1	1	as needed
PISTON, RUN 1	OHTGMOD-898-1		each test
PISTON, RUN 2	OHTGMOD-899-1		each test
PISTON, RUN 3	OHTGMOD-900-1		each test
PISTON, RUN 4	OHTGMOD-901-1		each test
PISTON, RUN 5	OHTGMOD-902-1		each test
PISTON, RUN 6	OHTGMOD-903-1		each test
O-RING, THRUST, CAM, GMOD	OHTGMOD-200-1	1	each test
O-RING, SHORT, REAR COVER, GMOD	OHTGMOD-201-1	1	each test
SEAL, LONG, REAR COVER, GMOD	OHTGMOD-202-1	1	each test
RING, ENGINE SET, SPECIAL TEST, GMOD, RUN 1	OHTGMOD-03898-1		
RING, ENGINE SET, SPECIAL TEST, GMOD, RUN 2	OHTGMOD-03899-1		
RING, ENGINE SET, SPECIAL TEST, GMOD, RUN 3	OHTGMOD-03900-1		
RING, ENGINE SET, SPECIAL TEST, GMOD, RUN 4	OHTGMOD-03901-1		
RING, ENGINE SET, SPECIAL TEST, GMOD, RUN 5	OHTGMOD-03902-1		
RING, ENGINE SET, SPECIAL TEST, GMOD, RUN 6	OHTGMOD-03903-1		
RING, SPECIAL TEST, TOP, RUN 1	GMOD03898-TOP1		
RING, SPECIAL TEST, TOP, RUN 2	GMOD03899-TOP2		
RING, SPECIAL TEST, TOP, RUN 3	GMOD03900-TOP3		
RING, SPECIAL TEST, TOP, RUN 4	GMOD03901-TOP4		
RING, SPECIAL TEST, TOP, RUN 5	GMOD03902-TOP5		
RING, SPECIAL TEST, TOP, RUN 6	GMOD03903-TOP6		
RING, SPECIAL TEST, SECOND, RUN 1	GMOD03898-SECOND1		
RING, SPECIAL TEST, SECOND, RUN 2	GMOD03899-SECOND2		
RING, SPECIAL TEST, SECOND, RUN 3	GMOD03900-SECOND3		
RING, SPECIAL TEST, SECOND, RUN 4	GMOD03901-SECOND4		
RING, SPECIAL TEST, SECOND, RUN 5	GMOD03902-SECOND5		
RING, SPECIAL TEST, SECOND, RUN 6	GMOD03903-SECOND6		
RING, RAIL	GMOD03X-01		

GMOD Parts Purchased from OHT

RING, EXPANDER	GMOD03X-02		
O-RING, THRUST, CAM, GMOD	OHTGMOD-200-1	1	each test
Rear Cover	OHTGMOD-015-1	1	
O-RING, SHORT, REAR COVER, GMOD	OHTGMOD-201-1	1	each test
SEAL, LONG, REAR COVER, GMOD	OHTGMOD-202-2	1	each test
MOUNT, FRONT, ENGINE	OHTGMOD-006-1		
MOUNT, REAR, ENGINE	OHTGMOD-007-1		
HOUSING, OBERG ASSEMBLY, W/ Teflon	OHT6A-012-4		
Gasket, Teflon, Oberg Housing	OHTGMOD 096-1		
FILTER, OBERG, 6", 60 MICRON	OHT6A-013-3		
Heat shield. Oil pan left	GMOD-005-32		
Heat shield. Oil pan right	GMOD-005-33		
Bolt, Flywheel	OHTGMOD-203-1	6	As needed

Section 11

Reagents

2-15-2016

Engine Build

- EF-411 Engine Assembly Lubricant
- Petroleum Jelly containing 100% White Petrolatum for holding the front and rear cover orings
- GM RTV 12378521 or 88864346 for the oil pan corners and flywheel bolt threads.
- Teflon Tape for plug/pipe threads not to come in contact with oil
- No. 2 Permatex Sealer for under the head of the side main cap bolts and oil gallery plug

Engine Degreasing Solvent

- Mineral Spirits meeting ASTM Specification D 235 Type II Class C
- Organic Solvent Penmul L460

Sunnen

- Sunnen Honing Fluid SHO-965

Ultrasonic Cleaner Chemicals

Purvis Industries

- Ultrasonic B Degreaser
- Ultrasonic 7 Soap

Brulin US Solution

- 815 GD
- 815 QR-DF